

FASTCAM Mini R Series

Hardware Manual

Rev. 4.04 E

Photron

WARNING

This equipment has been tested and found to comply with the limits for a Class A digital device, pursuant to part 15 of the FCC Rules. These limits are designed to provide reasonable protection against harmful interference when the equipment is operated in a commercial environment. This equipment generates, uses, and can radiate radio frequency energy and, if not installed and used in accordance with the instruction manual, may cause harmful interference to radio communications. Operation of this equipment in a residential area is likely to cause harmful interference in which case the user will be required to correct the interference at his own expense.

CAUTION:

Any changes or modifications not expressly approved by the party responsible for compliance could void the user's authority to operate the equipment.

The copyright of this manual is held by PHOTRON LIMITED.

Product specifications and manual contents are subject to change without notice.

PHOTRON LIMITED bears no responsibility for any results by using our products nor by applying this manual to any operations.

Introduction

Thank you for your purchase of Photron's high-speed camera system, the "FASTCAM Mini R series" (referred to below as the system).

This manual is the hardware manual for **Mini R3-4K** (hereafter R3), and **Mini R5-4K** (hereafter R5).

For Photron FASTCAM Viewer 4 (PFV4), please refer to the "PFV4 User's Manual".

This manual contains the operating instructions and warnings necessary for using the system. Before using the system, read the entire manual.

If any part of this manual is unclear, contact Photron using the contact information printed at the back of the manual.

After you finish reading the manual, store it in a safe place along with the warranty card and refer back to it when necessary.

Using the Manual

This section explains the layout of the manual.

- Introduction

The introduction explains the manual and safety precautions.

- Chapter 1, Setup

This chapter gives an overview of the components that make up the system. It also explains basic keypad operation and a list of items that should be checked before using the system.

- Chapter 2, Recording

This chapter explains operations related to recording.

- Chapter 3, Product Specifications

This chapter explains the system's specifications.

- Chapter 4, Warranty





This chapter explains about the warranty.

- Chapter 5, Contacting Photron

This chapter lists the contact information to use when contacting Photron if the system malfunctions or if a portion of the manual is unclear.

Manual Notation

The following icons and symbols are used in the explanations in this manual.

Icon/Symbol	Description
 IMPORTANT	This symbol indicates content that should always be read.
 CAUTION	This symbol indicates instructions that should always be followed when using the software, or things to be careful of when using the software.
 NOTE	This symbol indicates supplementary items to be aware of when using the system.
 REFERENCE	This symbol indicates the location of a reference.
“ ”	This symbol is used to indicate the names of items on a screen, references, dialog names, and connectors.
[]	This symbol is used to indicate menu names, and sub-menu names.

Using the System Safely and Correctly

To prevent injury to yourself and others, and to prevent damage to property, carefully observe the following safety precautions.

Photron has given its full attention to the safety of this system. However, the extent of damage and injury potentially caused by ignoring the content of the safety precautions and using the system incorrectly is explained next. Pay careful attention to the content of the safety precautions when using the system.



Warning

This symbol indicates actions that carry the risk that a person could receive a serious injury.



Caution

This symbol indicates actions that carry the risk that a person could receive a moderate injury, or that damage to physical property might occur.

- The safety precautions to be observed are explained with the following symbols.



This symbol indicates actions that require caution.



This symbol indicates actions that are prohibited and must be avoided.



This symbol indicates actions that must always be performed.



Warning



- Do not perform actions that will damage the AC cable or plug.
Do not damage the cable, modify it, use it near a heater, excessively bend, twist or pull on it, place heavy objects on it, or bundle it.
Using the cable when damaged can cause fire, electric shock, or a short circuit.



- Do not use the system in a manner which will exceed the rating of the power outlet or wiring equipment used.
Exceeding the power rating might cause a fire from excessive heat.



- Do not insert metallic objects inside, or pour liquids such as water on, the system.
Doing so can cause fire, electric shock, or malfunction from short circuit or heat.



- Do not disassemble or modify the system.
There are high voltages inside the system that can cause electric shock.



- Do not plug in or unplug the power cord with wet hands.
Doing so can cause electric shock.



- Make sure the power plug is fully insert into the socket.
Not fully plugging in the power cable can cause fire from electric shock or heat.



- When something is wrong with the system, unplug the power cable immediately.
 - When a foreign substance or liquid, such as metal or water, gets inside.
 - When the outer case is broken or damaged, such as from a fall.
 - When the system emits smoke, a strange smell, or strange sound.Using the system in these conditions might cause a fire or electric shock.



- Do not use the accessories by the usage that a manufacturer does not specify.
It may cause damage of protection.

Caution



- Always unplug the system when cleaning it or when it is unused for a long period of time. Leaving or storing the system connected to the power source might cause fire from insulation deterioration or electrical discharge.



- Consult Photron in advance when you perform an event by which laser light or direct rays fall on the image sensor surface.



- Do not set the system in a location where the temperature gets unusually hot. The trunk and inside of a car can get especially hot in summer. Doing so can cause the outer case and internal components to deteriorate or cause a fire.



- Do not place the system in a location prone to oily smoke or steam, or in a location with a lot of humidity or dust. Oil, moisture, and dust conduct electricity, which can cause a fire or electric shock.



- Use the system in an environment with an ambient temperature of 0 to +40 °C, humidity of 85 % RH or lower, maximum altitude of 2,000 m or lower, and no condensation. Use in a condition out of the above limits can cause malfunction.



- Do not store the equipment in a location where the temperature goes below -20 °C or higher than +60 °C. Be sure not to allow condensation to form inside the system.



- When shipping, remove the connecting cable and use the original packaging or a dedicated carrying case. Do not ship the equipment in an environment where the temperature goes below -20 °C or higher than +60 °C. Also, prevent condensation from forming during shipment.



- When installing the camera with a tripod, check the tripod load capacity and be careful not to exceed the load bearing capacity. Also, when using a tripod, make sure that the tripod, tripod screw, panhead, and others are properly set, and be careful not to let the tripod fall down.



- Depending on the temperature of this system at startup, startup may take time.



Handling of the AC Adapter

To ensure safe use of the Photron FASTCAM series, please follow the instructions for proper storage of the supplied AC adapter.

If there is any problem with the AC adapter or cable, stop using it immediately and contact your local Photron office.

■ Storage Method

- When storing the AC adapter or cable, make sure that no stress is placed on the root of the AC adapter or the cable.
- Do not wrap the cable around the AC adapter, but loosely bundle it.
- When storing the AC adapter in the camera's carrying case, store it so that no strain is placed on the root of the AC adapter and the cable.



Bad example

Cable is wound too tightly.



Strain on the root.



Good example

No strain on the root.



Cable is loosely bundled.

■ Appearance Check

- Before use, check the appearance of the AC adapter and cable for any abnormalities.
- If there are any cracks or tears on the surface, it may cause fire, electric shock, or short circuit.

Immediately stop using the AC adapter and contact your local Photron office.





European Union (and EEA) only



“CE” mark indicates that this product complies with the European requirements for safety, health, environment, and customer protection. “CE” mark equipments are intended for sales in Europe.



These symbols indicate that this product is not to be disposed of with your household waste, according to the WEEE Directive (2002/96/EC), the Battery Directive (2006/66/EC) and/or your national laws implementing those Directives.



This product should be handed over to a designated collection point, e.g., on an authorized one-for-one basis when you buy a new similar product or to an authorized collection site for recycling waste electrical and electronic equipment (EEE) and batteries and accumulators. Improper handling of this type of waste could have a possible impact on the environment and human health due to potentially hazardous substances that are generally associated with EEE. Your cooperation in the correct disposal of this product will contribute to the effective usage of natural resources.

For more information about the recycling of this product, contact your local city office, waste authority, approved scheme or your household waste disposal service or visit www.photron.com.

(EEA: Norway, Iceland, and Liechtenstein)



This product is in conformity with the protection requirements of EU Council Directive 2014/30/EU (Class A) on the approximation of the laws of the Member States relating to electromagnetic compatibility.

Warning: This is a Class A product. In a domestic environment, this product may cause radio interference, in which case the user may be required to take adequate measures.



Cleaning of the Image Sensor Surface

Electrostatic Discharge (ESD) events may cause immediate and unrecoverable damage to the image sensor.

Read the following instructions and take **EXTREME CARE** when cleaning the image sensor surface.



- ALWAYS take appropriate anti-static precautions when cleaning or working near the Image sensor.
- DO NOT use any form of cleaning equipment using electrostatic or 'charged fiber' technology.



- Discharge any electrostatic build up in your body by touching a grounded metallic surface before working near the camera sensor.
- Very gently, use only clean and dry air to remove dust from surface of the image sensor.
- To remove stubborn contamination, use the highest grade (e.g., VLSI grade) pure Isopropyl alcohol (IPA) with optical wipes of 'clean room' grade.
- Extreme care must be taken! Gently wipe across the sensor in a single action.
DO NOT rub to avoid abrasive damage to delicate optical coatings on the glass surface.

Contents

Chapter 1 Setup	14
1.1 Components and Accessories	15
1.1.1 Components.....	15
1.1.2 Options.....	15
1.1.3 Type.....	16
1.2 Part Names.....	17
1.2.1 Camera Body.....	17
1.2.2 Camera Body Part Names.....	18
1.2.3 Interchangeable Lens Mount	19
1.2.4 Status Display LEDs on the Rear of the Camera Body.....	20
1.2.5 Power Switch.....	21
1.2.6 Power Supply Connector, DC Cable	22
1.2.7 Gigabit Ethernet (GbE).....	25
1.2.8 RESET Switch.....	27
1.3 Input/Output Signal Types.....	30
1.3.1 TRIG SW IN Connector.....	30
1.3.2 INPUT 1, 2	31
1.3.3 IO INPUT Circuit Diagram.....	32
1.3.4 OUTPUT 1, 2.....	33
1.3.5 Using External Synchronization Signals	34
1.3.6 Synchronization with a variable frequency.....	36
1.3.7 Setting of Input/Output Signals and Sync Output Rate.....	37
1.3.8 IRIG IN (External Time Synchronization).....	39
1.3.9 IRIG-sync Operation.....	40
1.4 Device Connections	41
1.4.1 Minimum Equipment Connection	41
1.4.2 Camera Hub (Optional)	42
1.4.3 Power Supply (DC Jack).....	43
Chapter 2 Recording	44
2.1 Selecting Frame Rate / Resolution	45
2.1.1 Low Shutter Speed Mode.....	45
2.2 Selecting Shutter Speed	46
Chapter 3 Product Specifications	47
3.1 Specifications	48
3.1.1 Product Specifications.....	48
3.1.2 General Specifications.....	49
3.1.3 AC Adapter	49
3.1.4 Other Supported Function	50

3.1.5	Frame Rate and Resolution.....	51
3.1.6	Recordable Frames / Resolution	58
3.1.7	Recordable Time / Resolution.....	60
3.1.8	Shutter Speed List.....	62
3.1.9	Random Reset Delay / Inter Frame Time.....	63
3.2	Dimensions	65
3.2.1	Camera Body.....	65
3.2.2	AC Adapter	71
Chapter 4	Warranty	72
4.1	About the Warranty.....	73
Chapter 5	Contacting Photron	74
5.1	Contact Information	75
A.	Appendix	76
A.1.	Reference Information	77
A.1.1	Relative Spectral Response (R3 / R5, monochrome, type-A).....	77
A.1.2	Quantum Efficiency (R3 / R5, monochrome, type-A)	77
A.1.3	Relative Spectral Response (R3 / R5, color, type-A).....	78
A.1.4	Quantum Efficiency (R3 / R5, color, type-A).....	78

1

Chapter 1 Setup

This chapter gives an overview of the components that make up the system. It also explains a list of items that should be checked before using the system.

1.1 Components and Accessories

1.1.1 Components

Refer to the attached packing list for this product's standard components and accessories.

1.1.2 Options

The following options are available for the system.

1. Carrying Case
2. Canon EF Remote Control Mount Adapter
3. C Mount Adapter
4. M42 Mount Adapter
5. RJ45 Fixing Bracket for Mini R Series
6. Photron Master Camera Hub, Photron Camera Hub



Use only the components and options specified on the “1.1 Components and Accessories” for AC adapter / AC cable and others.

1.1.3 Type

For the system, there are monochrome and color versions, and for each of these versions, there are standard memory type of 8GB or 16GB and high capacity memory types of 32GB, and 64GB. When purchasing, it is possible to select from these models according to the application or your demands. The type categories are listed as follows.

- ◆ Camera type name and category (e.g. R5)



Item	List	Explanation
Max.Frame Rate at Full HD resolution	R3	3,000 fps
	R5	5,280 fps
Full Resolution	4K	Horizontal 4,096 x Vertical 2,304 pixel
Max. Frame Rate	150K	150,000 fps
	200K	200,000 fps
Sensor	M	monochrome
	C	color
Memory	8GB	8 gigabytes
	16GB	16 gigabytes
	32GB	32 gigabytes
	64GB	64 gigabytes
Sensor Version	A	Type-A sensor

1.2 Part Names

The system is composed of components including the camera body, AC adapter, and the “Photron FASTCAM Viewer” control software (referred to below as PFV).



For the camera body and the AC adapter

- Do not expose the camera body, AC adapter and other optional components to shock.
- Do not use in an area where flammable gas or dust is present.
- Do not place in an unstable location such as on an unstable platform or an incline.
- Do not disassemble or modify.
- Do not expose to liquids such as water.
- Do not subject to an excessive force.

1.2.1 Camera Body

The camera body contains IC memory for image recording and has been designed to be able to record high-speed images uncompressed.

The back of the camera body is equipped with the Gigabit Ethernet interface (1GbE/10GbE), which permits full camera control and data download possible via connection to a PC; the input/output connector, which allows external synchronization signals, trigger signals, IRIG time code.

A voltage output terminal is provided on the side of the camera body for external power supply, which can be used to control LED lighting, wireless modules, etc.

1.2.2 Camera Body Part Names

◆ R3 / R5 G type F Mount

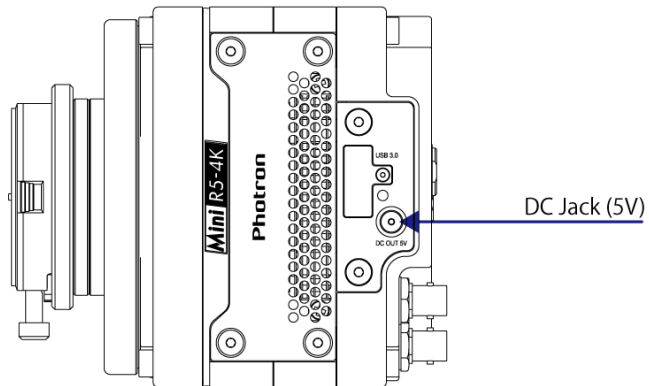
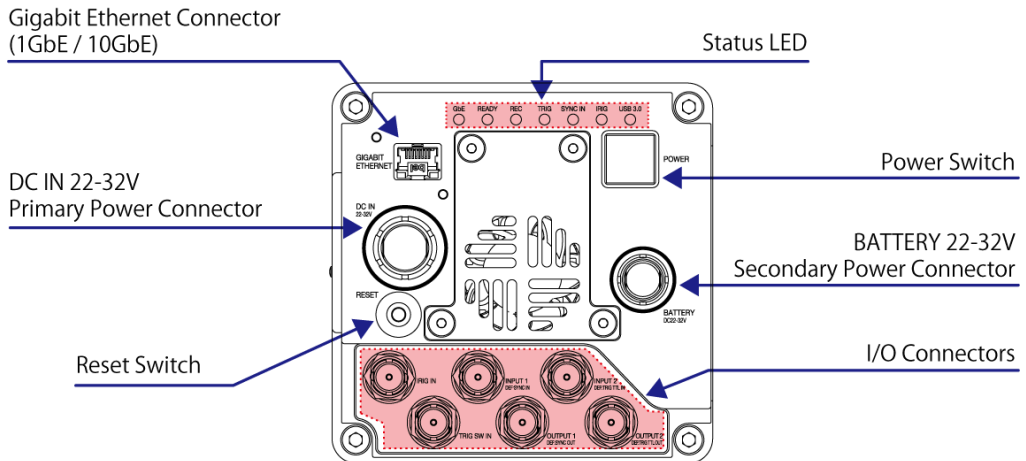
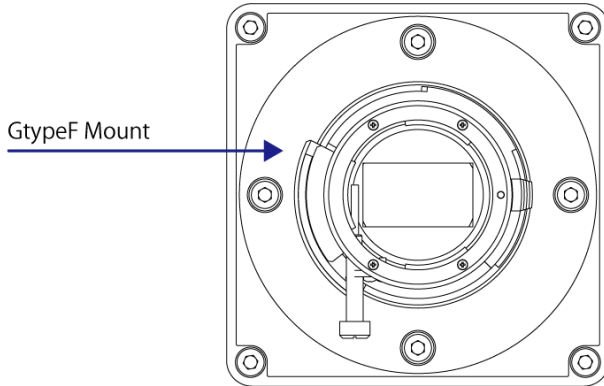

1.2.3 Interchangeable Lens Mount

The lens mount on the system can be changed according to the recording purpose. There are four types of interchangeable lens mounts, including options: “G type F Mount”, “C Mount”, “EF Mount”, and “M42 Mount”. The system has mechanical shutter as a standard feature.

◆ How to change the lens mount (G type F Mount to C Mount)

1. Remove the four M5 bolts with the hexagonal holes using the hexagonal wrench.
2. Remove the G type F Mount portion as a unit.
3. Install the C Mount unit using the bolts with hexagonal holes in the 90° diagonal holes.
4. After installation, always verify that the unit is not loose and does not rattle.

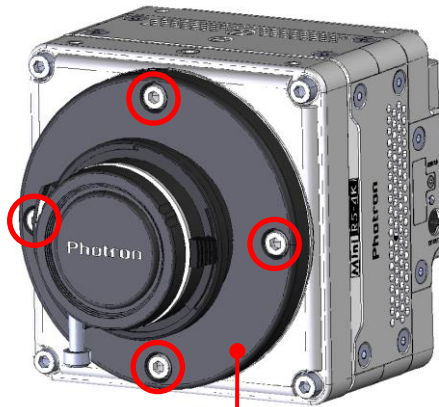

GtypeF mount (standard)



CAUTION







- For G type F Mount: Electronic aperture control for Nikon E type lenses is not supported.
- For EF Mount: Canon EF-S, EF-M, and RF type lenses cannot be attached.
- When using a C-mount or M42-mount, the following restrictions apply to the lens to be used.
C-mount: Protrusion from the lens mount flange to the image sensor (a) 7.5 mm maximum
M42-mount: Protrusion from the lens mount flange to the image sensor (a) 9.5 mm maximum

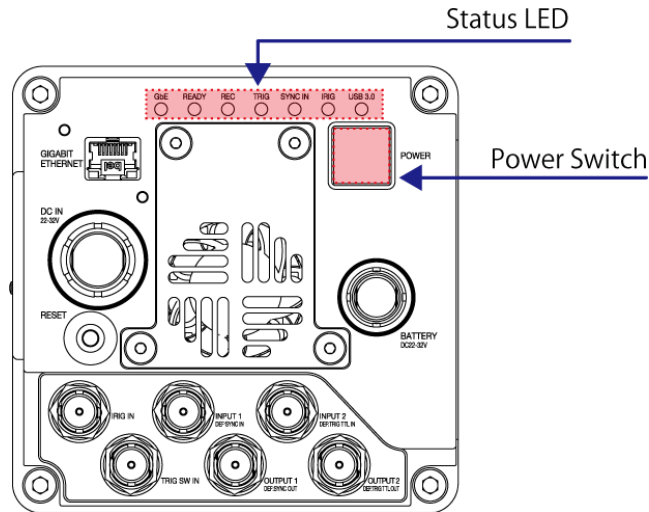

1.2.4 Status Display LEDs on the Rear of the Camera Body

There are a number of LEDs on the rear of the camera body. These LEDs indicate the status of the camera. The function of each LED is explained here.



Item	Color	ON	FLASHING	OFF
POWER		Power On	—	Power Off
GIGABIT ETHERNET		The Gigabit Ethernet interface is connected	Data is transferring	The Gigabit Ethernet interface is not connected
READY		—	Ready to record	Not ready to record
REC		Recording	ENDLESS recording	Not recording
TRIGGER		A trigger signal is present (being input) (The LED will illuminate for 0.1 second when the trigger signal is input)	—	The trigger signal is not present
SYNC IN		Synchronization signal is not input in external synchronization mode	Synchronization signal is input in external synchronization mode	Internal synchronization mode
IRIG		IRIG signal is not input in IRIG mode	IRIG signal is input in IRIG mode	IRIG mode off

1.2.5 Power Switch

Press the power switch on the back of the camera to turn the power on and off.

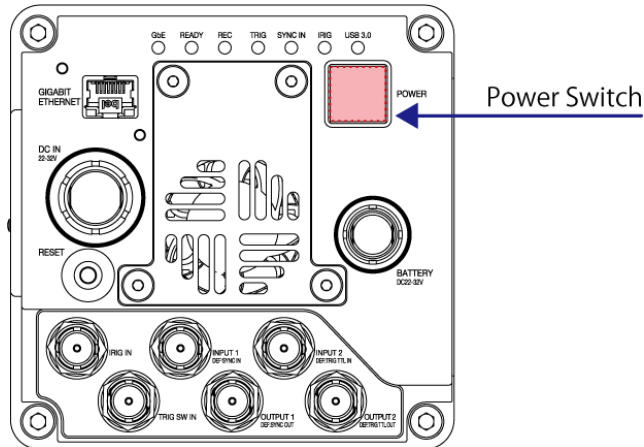

To prevent the power switch from being accidentally pressed during recording, causing the power to turn off and recording to fail, power off by the power switch is disabled when the camera is in recording standby or recording. With firmware version 4.1 or later, the power LED will turn off while the power remains on. After recording is complete and data has been downloaded, follow the steps below to reset the power switch status.

The power switch is pressed due to a shock or other cause while the camera is in Ready or Rec status.

The power LED turns off.

* Power remains on and recording continues.

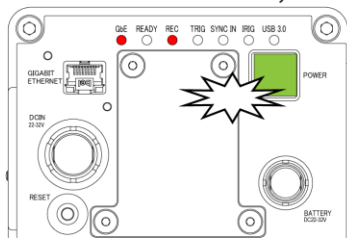

① Confirm that the REC LED is off and recording has finished. Download the data.

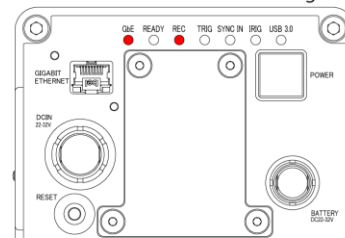

② Press the power switch.
* Power remains on, LED remains off.

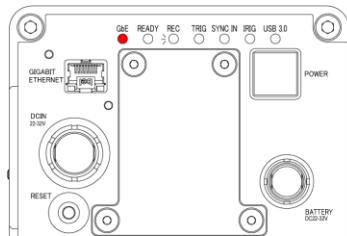

③ Press the power switch again.
* Power turns off.

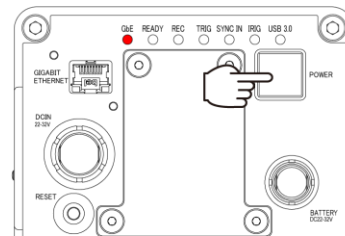

④ Reboot the camera.

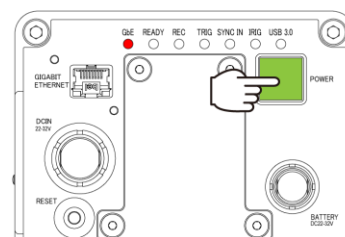
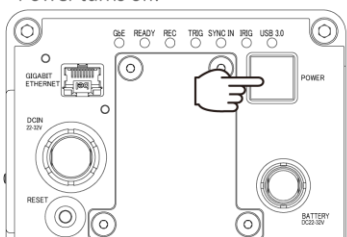

1.2.6 Power Supply Connector, DC Cable

This is a DC power supply input connector. Connect to the supplied AC adapter. Two power supply connectors “DC IN” and “BATTERY” are prepared for this product. “DC IN” is the primary, and it is used with priority. When the voltage supplied from “DC IN” falls below a certain level and the voltage is supplied from “BATTERY”, it will seamlessly switch to the power supply from the secondary “BATTERY”.

The cable connector is optionally available. When using other power supplies, construct a cable using the pin diagram below as a reference.

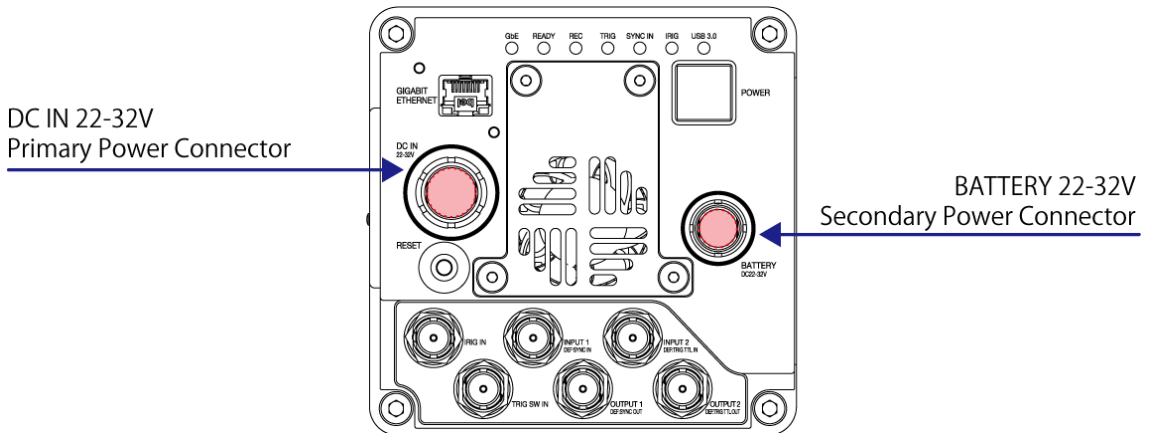

Warning

When using the connector pins directly, refer to the chart above and ensure the wiring is correct. If the wiring is incorrect, not only is there the danger of the system malfunctioning, but also of fire and electric shock.



Warning

Do not use a power supply which does not meet the system’s specifications, or a power supply you cannot guarantee the safety of.

By using a power supply out of the system specifications, not only is there the danger of the system malfunctioning, but also of fire and electric shock.



Warning



Use an external power supply with the suitable rating which was estimated by IEC61010-1:2010, AMD1:2016 and separated from the main circuit by double insulation or reinforced insulation.



Warning

Although this camera can be used outdoors, the AC adapter is not usable outdoors. When using the system outdoors, prepare another power supply.

◆ R3 / R5 Power Connector (DC IN 22-32V)

Power Connector Pin Diagram	Cable (Body side) Pin Diagram	Cable (Adapter side) Pin Diagram
		
ECJ.2B.316.CLD	FGJ.2B.316.CLLD9	



Connector Name	Signal Name	Pin No.	Body Side Connector Model Name (Manufacturer)	Cable Side Connector Model Name (Manufacturer)
Power connector (Body side)	GENERAL IN 2	1	ECJ.2B316.CLD (LEMO)	FGJ.2B316.CLLD9 (LEMO)
	NC (1kohm_pulldown)	2		
	GENERAL IN 1	3		
	NC (1kohm_pulldown)	4		
	GENERAL OUT 1	5		
	NC (1kohm_pulldown)	6		
	NC (1kohm_pulldown)	7		
	IRIG IN	8		
	POWER IN (24V)	9		
	POWER IN (24V)	10		
	POWER IN (24V)	11		
	GND	12		
	GND	13		
	GND	14		
	IRIG_GND	15		
	NC (1kohm_pulldown)	16		
DC Cable (Adapter side)	+Vo	1	-	Power pin 4 pin Type
	+Vo	2		
	GND	3		
	GND	4		



CAUTION

The power connector has IN/OUT signals in addition to the power supply. Each connector has its own I/O connector (BNC), but they cannot be used at the same time.

◆ R3 / R5 Battery Connector (BATTERY 22-32V)

Power/Battery Connector Pin Diagram	Cable (Body side) Pin Diagram	Cable (Adapter side) Pin Diagram
		
ECJ.1B304.CLD	FGJ.1B.304.CYMD62Z	

Connector Name	Signal Name	Pin No.	Connector Model Name (Manufacturer)
Power connector (Body side)	+Vo	1	ECJ.1B304.CLD(LEMO)
	+Vo	2	
	GND	3	
	GND	4	
DC Cable (Body side)	+Vo	1	FGJ.1B.304.CYMD62Z (LEMO)
	+Vo	2	
	GND	3	
	GND	4	
DC Cable (Adapter side)	+Vo	1	Power pin 4 pin Type
	+Vo	2	
	GND	3	
	GND	4	

1.2.7 Gigabit Ethernet (GbE)

This system has an Ethernet connector (common RJ45 connector) for communicating with the PC.

NOTE

The optional RJ45 fixing bracket can be used to fix the LAN cable to the RJ45 connector.

Contact Photron If you are concerned about LAN cable disconnection, such as when using the product in an environment where shocks are applied.

Gigabit Ethernet Connector (1GbE / 10GbE)

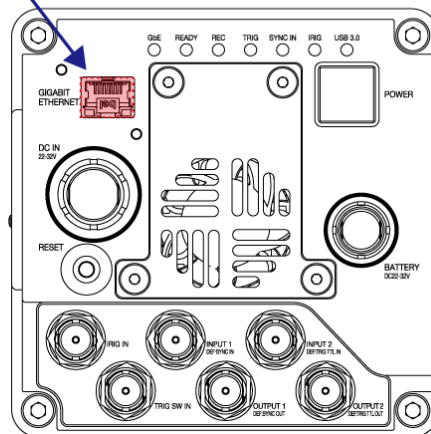

◆ For 1GbE connection

Connect a 1000BASE-T compatible interface board (commercially available) and this product with a LAN cable. For the LAN cable, prepare a UTP or STP Cat 5e (enhanced category 5) or higher LAN cable (UTP: Unshielded Twisted Pair, STP: Shielded Twisted Pair).

Being compliant with the 1000BASE-T specification, the maximum cable length is 100 m. One PC can connect to a maximum of 64 Photron Gigabit Ethernet interface equipped cameras using a hub. When connecting multiple devices, connect through a switching hub that can connect to 1000BASE-T. The maximum length of the cable that connects the system (or PC) to the switching hub is also 100 m.

◆ For 10GbE connection

Connect a 10GBASE-T compatible interface board (commercially available) and this product with a LAN cable. For the LAN cable, prepare a Cat 7 (Category 7) or higher STP cable.

Being compliant with the 10GBASE-T specification, the maximum cable length is 100 m. One PC can connect to a maximum of 64 Photron Gigabit Ethernet interface equipped cameras using a hub. When connecting multiple devices, connect through a switching hub that can connect to 10GBASE-T. The maximum length of the cable that connects the system (or PC) to the switching hub is also 100 m.

NOTE

- Photron recommends using an STP cable over long distances or in noisy locations.
- The 10GbE connection feature is supported with any camera firmware version of this system. However, the 10GbE feature may be disabled in some cases even if the firmware version is met. Contact Photron for support.
- You can check if the 10GbE setting is enabled from [Function Panel] - [Camera controls] - [Camera list].

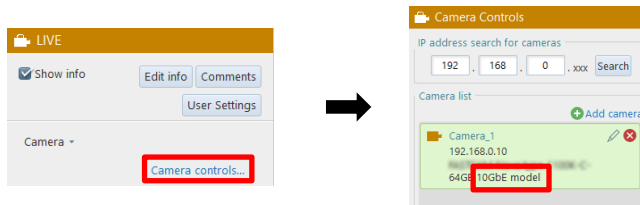

- If the camera has a 10GbE connection, “10GbE” will be displayed next to the [Edit] button in the camera list.

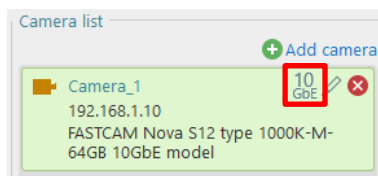

IMPORTANT

The camera's factory default IP address is below:

IP ADDRESS: 192.168.0.10

PORT: 2000 (UDP, fixed, unchangeable)

CAUTION

- Depending on the environment, 10GbE connection may not be stable. Check the operation in advance or contact Photron for support.
- When connecting via 10GbE, make sure that the PC's network card and hub are compatible with 10GBASE-T.
If you connect the camera to a network card that does not support 10GBASE-T via a hub that supports 10GBASE-T, the PC will not be able to receive commands from the camera and the camera will freeze and will not operate properly.
Use a network card that supports 10GBASE-T.

1.2.8 RESET Switch

There is RESET switch on the back of the system.

■ Camera IP Address Initialization

When the IP address is not sure, for instance after changing the address, an IP Address Initialization operation is recommended. In this case, the IP address will be reset to **192.168.0.10** as the factory settings.

① Press and hold the RESET switch on the rear side. All LEDs light up.

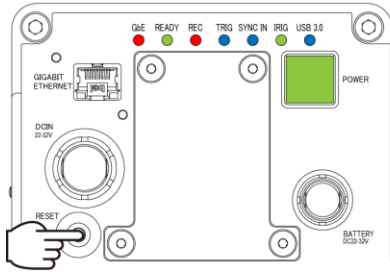

② The LEDs turn off in order from right to left.

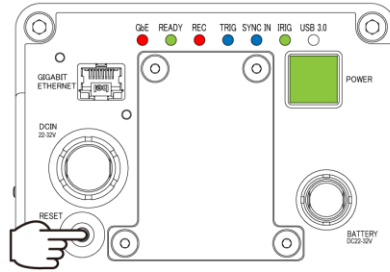

③ All LEDs except GbE turn off.

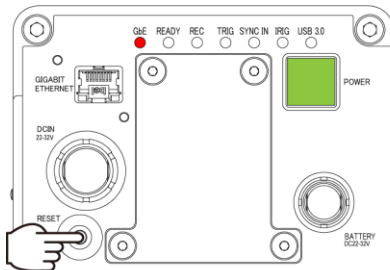

④ All LEDs except GbE blink once.

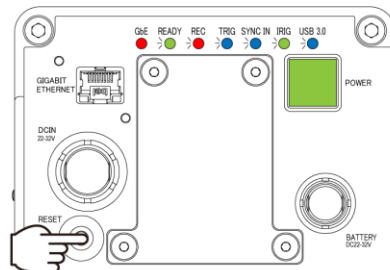

⑤ When all the LEDs light up, release the RESET switch.

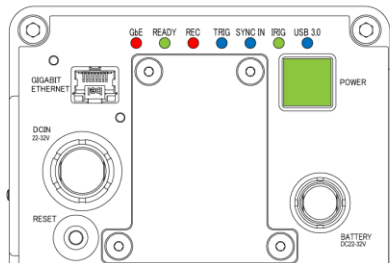

⑥ Reboot the camera. After rebooting, the IP address will be initialized.

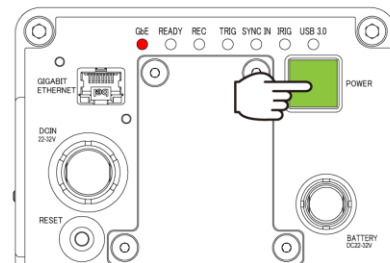

CAUTION

- If the RESET switch is released while the LEDs light up and turn off repeatedly from bottom to top, the IP address initialization will not be completed. Be sure to keep pressing the switch until all LEDs blink and then light up.
- If you continue to hold down the RESET switch after IP address initialization, “Reset to the Factory Default” will be executed.

■ Reset to the Factory Default

Camera settings can be reset to the factory default state by the following procedure.

① Press and hold the RESET switch on the rear side. All LEDs light up.

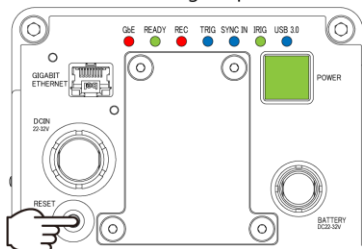

② The LEDs turn off in order from right to left.

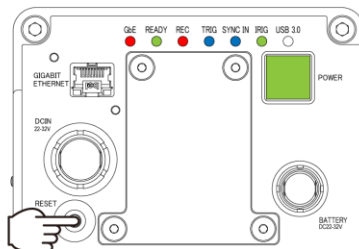

③ All LEDs except GbE turn off.

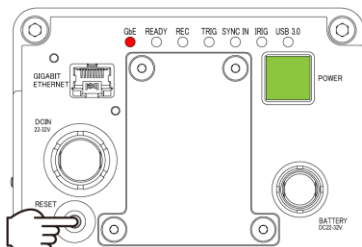

④ All LEDs except GbE blink once.

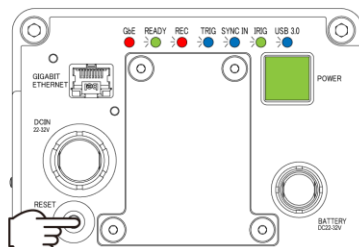

⑤ All the LEDs light up.

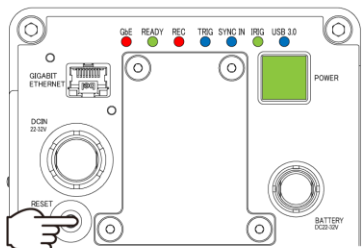

... x 3 times

⑥ All LEDs except GbE keep blinking.

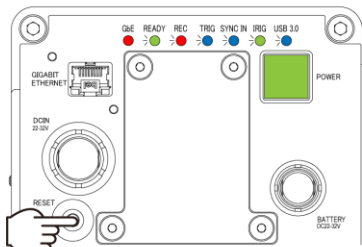

⑦ Release the RESET switch.

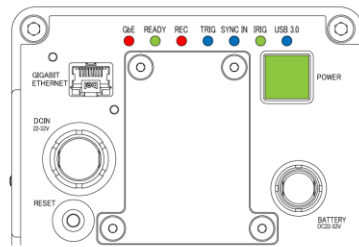

⑧ Reboot the camera. After rebooting, the camera is initialized to factory default.

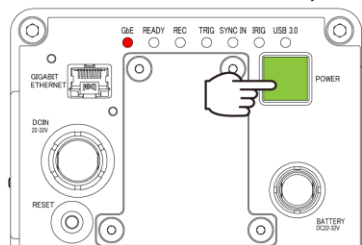



CAUTION

- When the LEDs light up and turn off repeatedly from bottom to top for three times and the LEDs keep blinking, the system is reset to factory default.
- If you release the RESET switch before the LEDs keep blinking, only the IP address initialization is performed.
- When the factory default is performed from PFV, all the LEDs keep lighting up, when the initialization is accomplished.

1.3 Input/Output Signal Types

With the system, many signals can be input and output through the I/O connector. Signals that can be input and output from the I/O connectors are listed below.



A signal other than the specified signal must not be input to the respective connectors. Use extreme caution as there is a risk of damage to both, the input device and the output device.

1.3.1 TRIG SW IN Connector

This trigger is input during the READY or ENDLESS recording state by contact between the BNC connector's shield and a center pin (switch closure). The center pin normally has voltage flowing through it. Use caution to avoid contact with other pins.

Connector Name (Input System)	Menu	Signal
TRIG SW IN	None	Contact signal

1.3.2 INPUT 1, 2

The effect when a signal is input is described below and can be optionally selected and set.

The input voltage is 0 V to +12 V (H level +3.3 V to +12 V), positive or negative polarity, pulse width is 200 nsec or greater.

Default settings are INPUT1 connector is assigned “SYNC POS”, INPUT2 connector is assigned “TRIG POS”.

Menu Display	Description	Signal (Input Signal Conditions)
TRIG POS	Inputs a positive polarity trigger signal.	FET Input 0 V to +12 V (H level +3.3 V to +12 V), Positive Polarity
TRIG NEG	Inputs a negative polarity trigger signal.	FET Input 0 V to +12 V (H level +3.3 V to +12 V), Negative Polarity
READY POS	Inputs a positive polarity READY signal. By inputting in the live state, switch READY ON/OFF. In addition, by inputting while recording, cancel the recording state.	FET Input 0 V to +12 V (H level +3.3 V to +12 V), Positive Polarity
READY NEG	Inputs a negative polarity READY signal. By inputting in the live state, switch READY ON/OFF. In addition, by inputting while recording, cancel the recording state.	FET Input 0 V to +12 V (H level +3.3 V to +12 V), Negative Polarity
SYNC POS	Inputs the signal with positive polarity. Input the synchronization signal from the camera or external device.	FET Input 0 V to +12 V (H level +3.3 V to +12 V), Positive Polarity
SYNC NEG	Inputs the signal with negative polarity. Input the synchronization signal from the camera or external device.	FET Input 0 V to +12 V (H level +3.3 V to +12 V), Negative Polarity
EVENT POS	Input the signal with positive polarity. By inputting during recording, “Event marker” is displayed separately from the trigger point in the data after recording.	FET Input 0 V to +12 V (H level +3.3 V to +12 V), Positive Polarity
EVENT NEG	Input the signal with negative polarity. By inputting during recording, “Event marker” is displayed separately from the trigger point in the data after recording.	FET Input 0 V to +12 V (H level +3.3 V to +12 V), Negative Polarity



NOTE

The event marker can store ten positions within a sequence.

1.3.3 IO INPUT Circuit Diagram

◆ R3 / R5

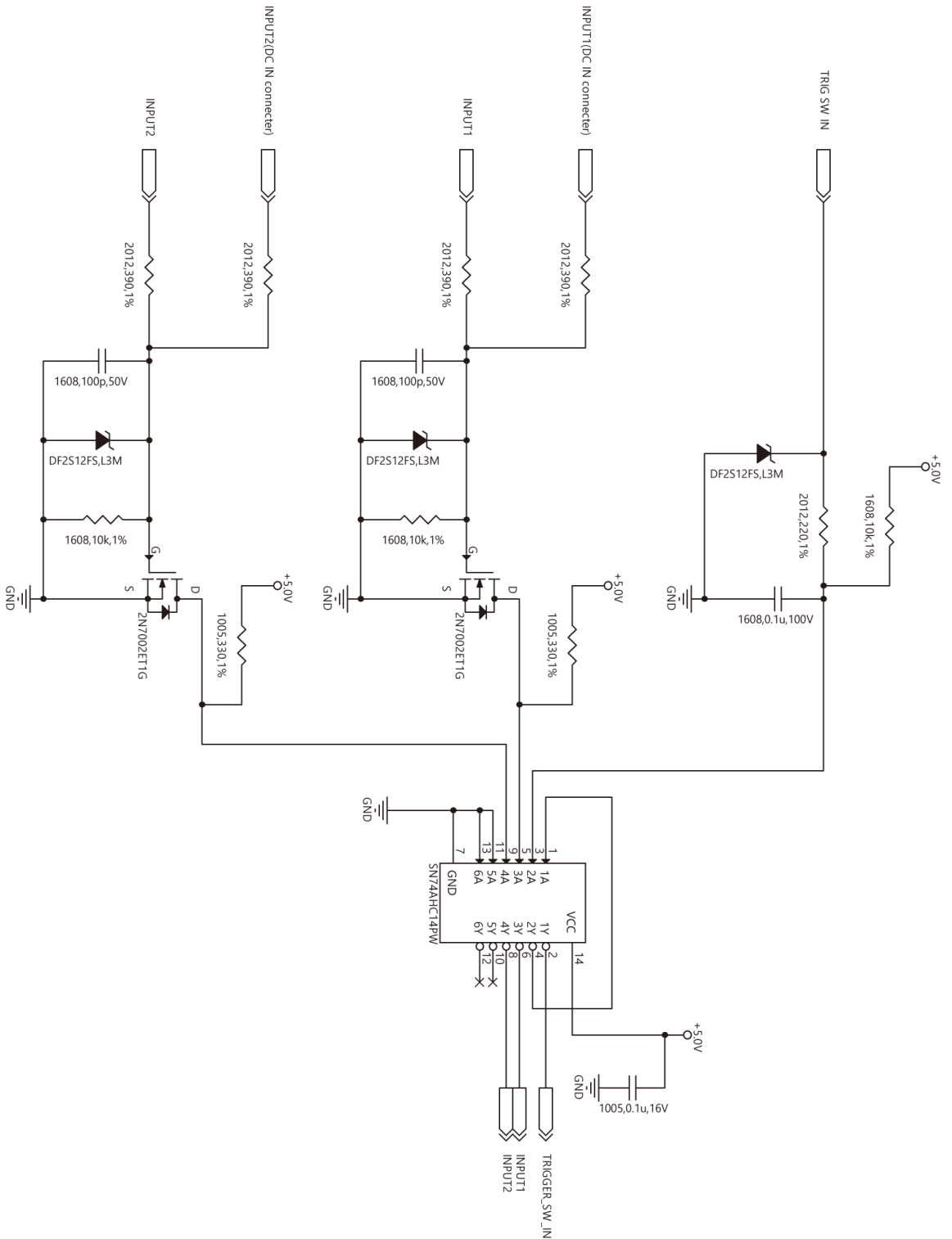

1.3.4 OUTPUT 1, 2

These are also BNC connectors. The signals below can be changed and output from PFV. The output voltage is 0 V to +5 V, positive or negative polarity, pulse width can be changed. Default settings are OUTPUT1 connector is “SYNC POS”, OUTPUT2 is “TRIG POS”.

Menu Display	Contents	Signal Type
SYNC POS	Outputs a positive polarity vertical synchronization signal.	+5 V CMOS output, Positive Polarity
SYNC NEG	Outputs a negative polarity vertical synchronization signal.	+5 V CMOS output, Negative Polarity
EXPOSE POS	Outputs the sensor’s exposure interval at H level.	+5 V CMOS output, Positive Polarity
EXPOSE NEG	Outputs the sensor’s exposure interval at L level.	+5 V CMOS output, Negative Polarity
REC POS	Outputs an interval signal during recording at H level.	+5 V CMOS output, Positive Polarity
REC NEG	Outputs an interval signal during recording at L level.	+5 V CMOS output, Negative Polarity
TRIG POS	Outputs the trigger signal received by the camera at H level.	+5 V CMOS output, Positive Polarity For TRIG SW IN Normally Open, approx. 23 μ sec Normally Close, approx. 23 μ sec For TRIG TTL IN POS: approx. 157 nsec NEG: approx. 170 nsec
TRIG NEG	Outputs the trigger signal received by the camera at L level.	+5 V CMOS output, Negative Polarity For TRIG SW IN Normally Open, approx. 23 μ sec Normally Close, approx. 23 μ sec For TRIG TTL IN POS: approx. 157 nsec NEG: approx. 170 nsec
READY POS	Outputs a signal at H level during the trigger wait state (ENDLESS recording state with MANUAL trigger). Available only for MANUAL trigger.	+5 V CMOS output, Positive Polarity
READY NEG	Outputs a signal at L level during the trigger wait state (ENDLESS recording state with MANUAL trigger). Available only for MANUAL trigger.	+5 V CMOS output, Negative Polarity
IRIG RESET POS	Outputs the camera’s internal IRIG reset signal (1PPS) at H level.	+5 V CMOS output, Positive Polarity
IRIG RESET NEG	Outputs the camera’s internal IRIG reset signal (1PPS) at L level.	+5 V CMOS output, Negative Polarity

1.3.5 Using External Synchronization Signals

An external synchronization mode to synchronize to an external signal is provided on the system. By using an external synchronization signal, recording can be conducted using multiple cameras to synchronize the timing of the shots or to also synchronize the shots with external measuring devices and lighting. The procedure and precautions for using the external synchronization signal are explained below.

■ Inputting an External Synchronization Signal

When SYNC POS/NEG is selected for INPUT 1 or 2, an external synchronization signal can be input with the system. See the chart below for external synchronization input settings.

Menu Display	Description
OFF	Sets external synchronization off, operates independently.
ON CAM	The camera synchronizes external signals lower than the currently set frequency. The frequency set at the beginning is displayed.
ON OTHERS	The camera synchronizes the signal that was input when the setting is changed to ON OTHERS. The frequency at the time of setting change is displayed, and the system synchronizes signals lower than this frequency. After synchronization setting, shutter speed and resolution can be changed but frame rate can not be changed.

NOTE

When changing to the “ON OTHERS” setting without inputting the synchronization signal from the outside, the state will be “50 Hz (E-Sync)”.

After that, even if you input the synchronization signal, it will operate at 50 Hz so execute “ON OTHERS” setting again after inputting the synchronization signal.

CAUTION

- The frequency which can input during ON OTHERS setting is limited to integer frequency. Inputting a signal for instance at 1000.5 Hz may cause dropped frames.
- When synchronizing the system at 7,200 fps or less and 1/frame shutter speed, the exposure time is slightly shorter. For rough indication, the reduced time is approx. 0.1 μsec for 1,000 Hz operation, approx. 1.8 μsec for 50 Hz, and approx. 9 μsec for 10 Hz.

■ Outputting an External Synchronization Signal

The system can externally output a synchronization signal. See the chart below for external synchronization output settings.

Menu Display	Description	Signal Type	Delay Time
SYNC POS	Outputs a positive polarity vertical synchronization signal.	CMOS (74ACT541 buffer) output, positive polarity	Approx. 525 to 542 nsec
SYNC NEG	Outputs a negative polarity vertical synchronization signal.	CMOS (74ACT541 buffer) output, negative polarity	Approx. 536 to 552 nsec

■ When the external sync signal is interrupted

When the external sync setting is “ON CAM” or “ON OTHERS”, the operation while no external sync signal input is as follows.

- No sync signal with “ON CAM” setting:
Stop updating live image (frame rate is setting value on PFV4).
- No sync signal with “ON OTHERS” setting:
Stop updating live image (frame rate synchronized with the sync signal if the sync signal was input at the time of ON OTHERS setting, or 50 fps if the sync signal was not input at the time of setting).

By checking the “Operates independently when the external sync signal is interrupted” checkbox in the External signal I/O port settings under [MENU] - [Configuration] - [I/O] in PFV4, the camera can run itself (continues updating live images) at the frame rate locked by the setting or ON OTHERS. (Unchecked in PFV4 default settings)

- “ON CAM” setting with no sync signal and with self-driving check:
Live image updates continue (frame rate is setting value on PFV4).
- “ON OTHERS” setting with no sync signal and with self-drive check:
Live image update continued (frame rate synchronized with the sync signal if the sync signal was input at the time of ON OTHERS setting, or 50 fps if the sync signal was not input at the time of setting).

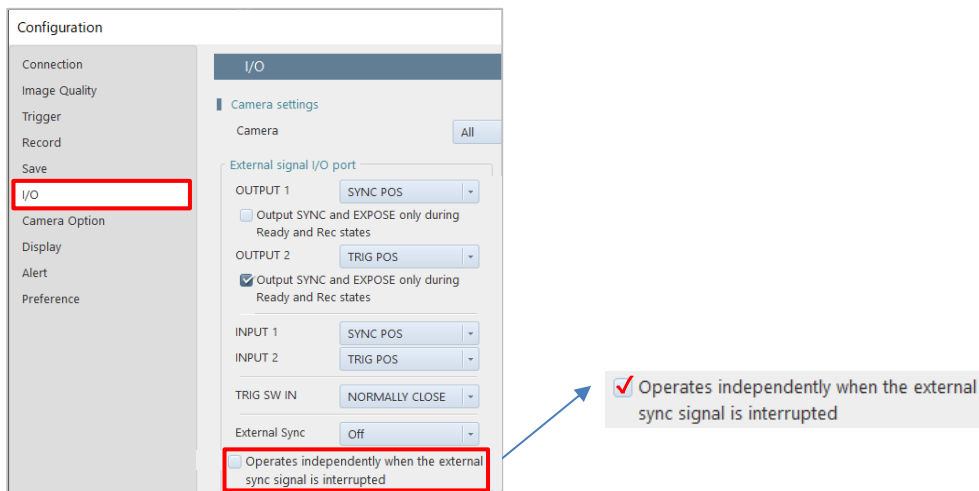

1.3.6 Synchronization with a variable frequency

When the system receives synchronization signal via external input terminals, the system can operate with the frame rate and resolution specified at the start of recording as the maximum value, following the synchronization signal up to 2 Hz even in the recording mode.

NOTE

- When an input sync signal is variable, or when it exceeds the upper limit frequency, the output image quality might be poor.
- Example of the variable frequency synchronization (ON CAM).

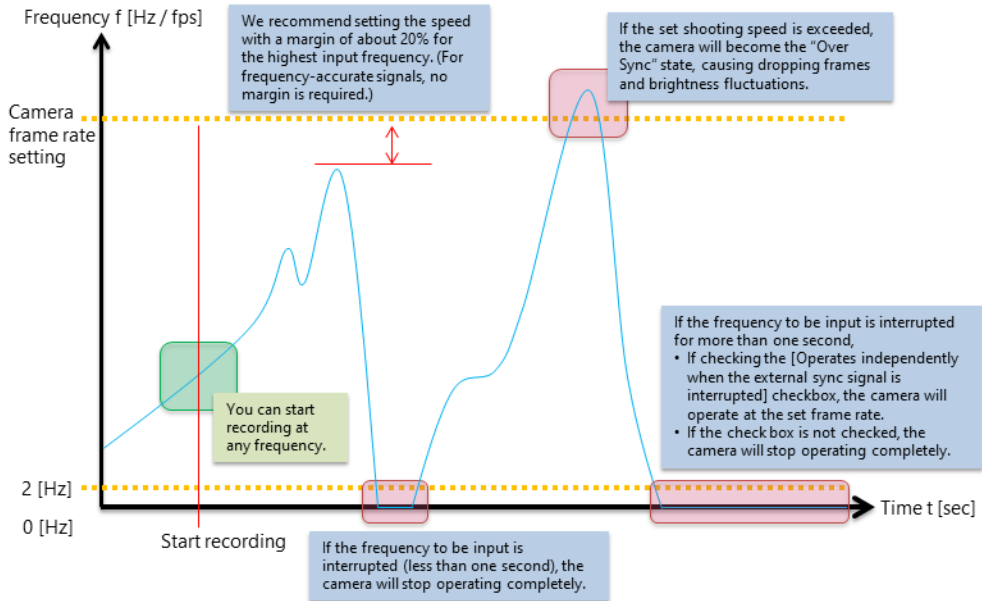

- Example of the variable frequency synchronization (ON OTHERS).

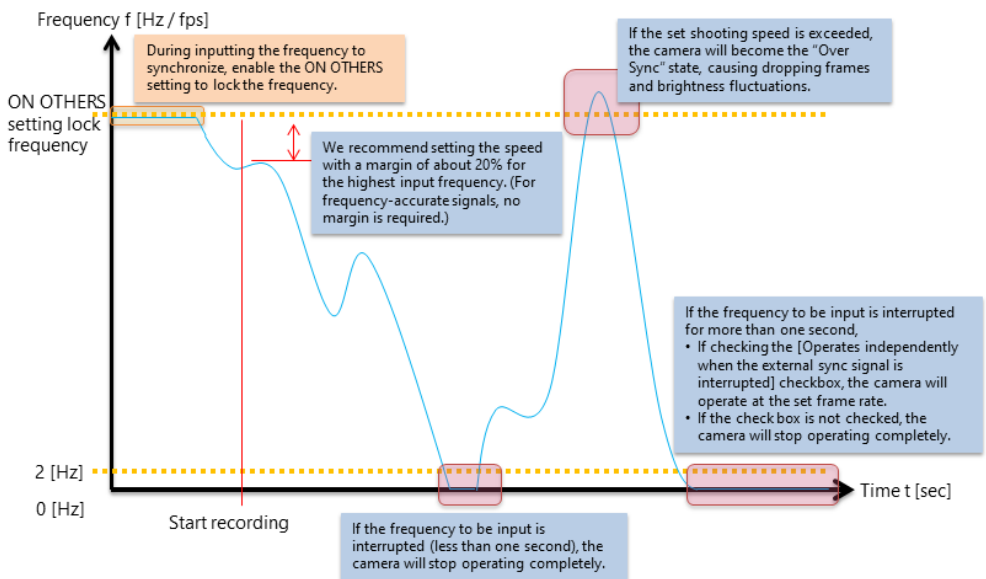

1.3.7 Setting of Input/Output Signals and Sync Output Rate

With the system, you can set the signal delay time or pulse width for the various signals that are input and output. Pulse width and delay settings for the various signals to input/output are made with PFV or the remote controller (optional). The content of each setting is listed in the chart below.

Setting Item	Setting Range (Value)
TRIG TTL IN DELAY	0 to 5 sec 100 nsec units
SYNC IN DELAY	0 to 1/frame rate -2 μ sec, 100 nsec units
TRIG OUT WIDTH	1 μ sec to 1 msec, 100 nsec units
SYNC OUT DELAY	0 to 1/frame rate -2 μ sec, 100 nsec units
SYNC OUT WIDTH	1 μ sec to 1/frame rate -2 μ sec, 100 nsec units
EXPOSE OUT DELAY	0 to 1/frame rate -2 μ sec, 100 nsec units
Sync output rate	0.5, 1, 2, 4, 6, 8, 10, 20, 30 (* x1 is the default setting)

◆ Sync output rate

Output a SYNC (vertical synchronization signal) from SYNC OUT that is x times SYNC.

■ Example: For Sync output rate setting of 2.

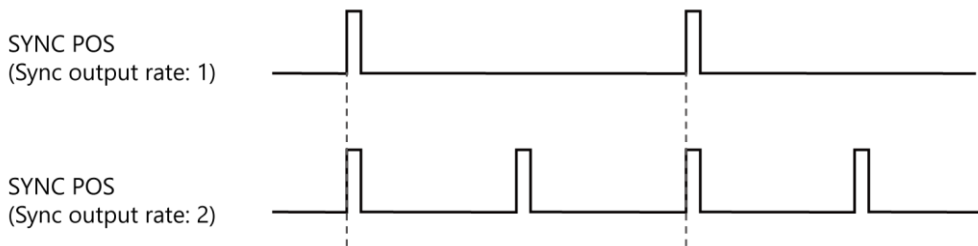

■ Example: For Sync output rate setting of 4.

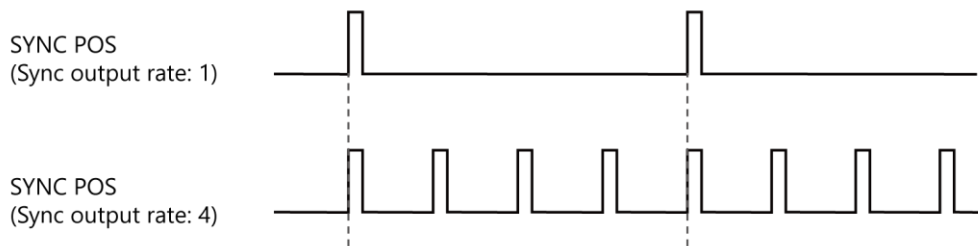



CAUTION

- When Sync output rate is set to a large value with a high frame rate, the setting may result in frequency errors.
- There are following limitations in Sync output rate function.

Frame Rate		Restriction
	to 60,000 fps	No Limit
60,001 fps	to 90,000 fps	x30 is unavailable
90,001 fps	to 200,000 fps	x20 and x30 are unavailable

- The following signal input cannot be accepted during the delay period.
Example: If 100 msec of delay is applied, the trigger is recognized 100 msec after trigger input, but the trigger input during that 100 msec will be canceled.

1.3.8 IRIG IN (External Time Synchronization)

The system supports IRIG-B input and can add an IRIG code to each recorded frame. The sample timing for the IRIG code is once each frame.

The recorded IRIG code is displayed on “PFV”.

◆ IRIG Code Input Specification

Connector	BNC
Code Format	IRIG-B (122) Analog
Amplitude	1.0Vp-p min, 8.0Vp-p max
Modulation Ratio	3:1 to 6:1
Typical modulated carrier signal ratio	10:1



CAUTION

Limitation of use of IRIG code

With the Image Trigger function, IRIG code cannot be used when the specified number of frames is 32 or fewer in RANDOM MANUAL trigger mode.



NOTE

- IRIG Time Code is used when temporally synchronizing a camera with external equipment.
- It is a convenient function when apparatus is physically separated.
- When the IRIG code is being input, the IRIG code is displayed in white, and □ is displayed to the left.
- When the IRIG code is not being input, the IRIG code is displayed in grey. At that time, the counter is the camera's internal counter, and it continues to count.

1.3.9 IRIG-sync Operation

This camera system supports IRIG-sync operation, in which the sensor drive signal is synchronized with the input of IRIG-B signal.

◆ How IRIG-sync operation works?

In IRIG-sync operation, the image sensor is driven by the timing signal shown below. Exposure to the sensor starts at the start of the IRIG-1PPS signal.

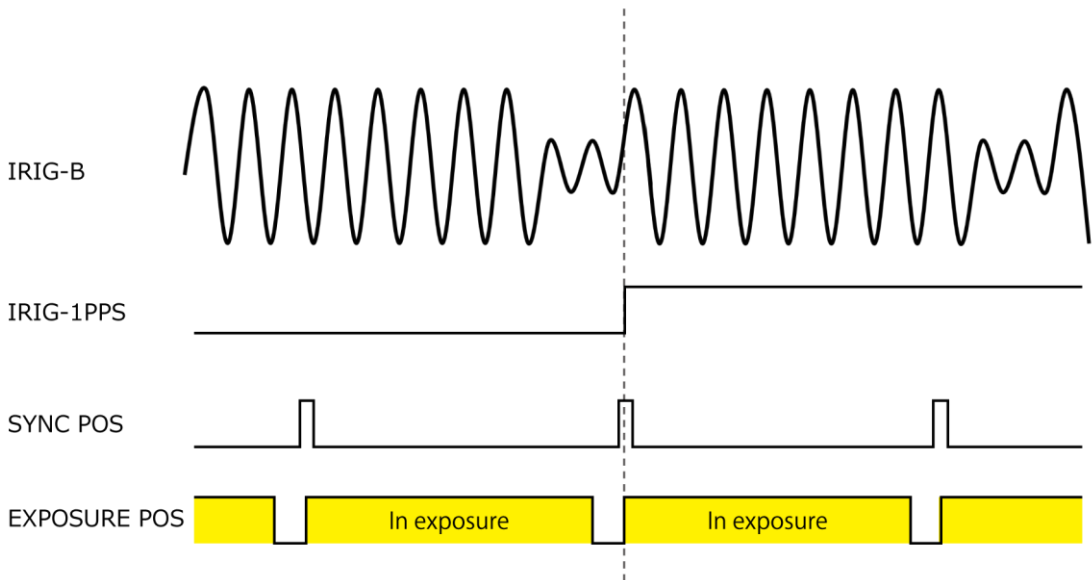

IRIG-B : IRIG code that is input to the camera
IRIG-1PPS : 1PPS timing of the IRIG code
SYNC POS : Camera's vertical sync signal
EXPOSURE POS : Exposure to the camera sensor

CAUTION

- The maximum frame rate for IRIG-sync operation is as follows.
- R3 / R5: 30,000 fps
- The IRIG signal must be input to the camera from the IRIG signal generator before enabling IRIG synchronous recording.
If the IRIG synchronous recording setting is preset, the IRIG signal must be input to the camera from the IRIG signal generator before the camera is activated.

1.4 Device Connections

1.4.1 Minimum Equipment Connection

The minimum connection for using the camera is as follows.

◆ R3 / R5

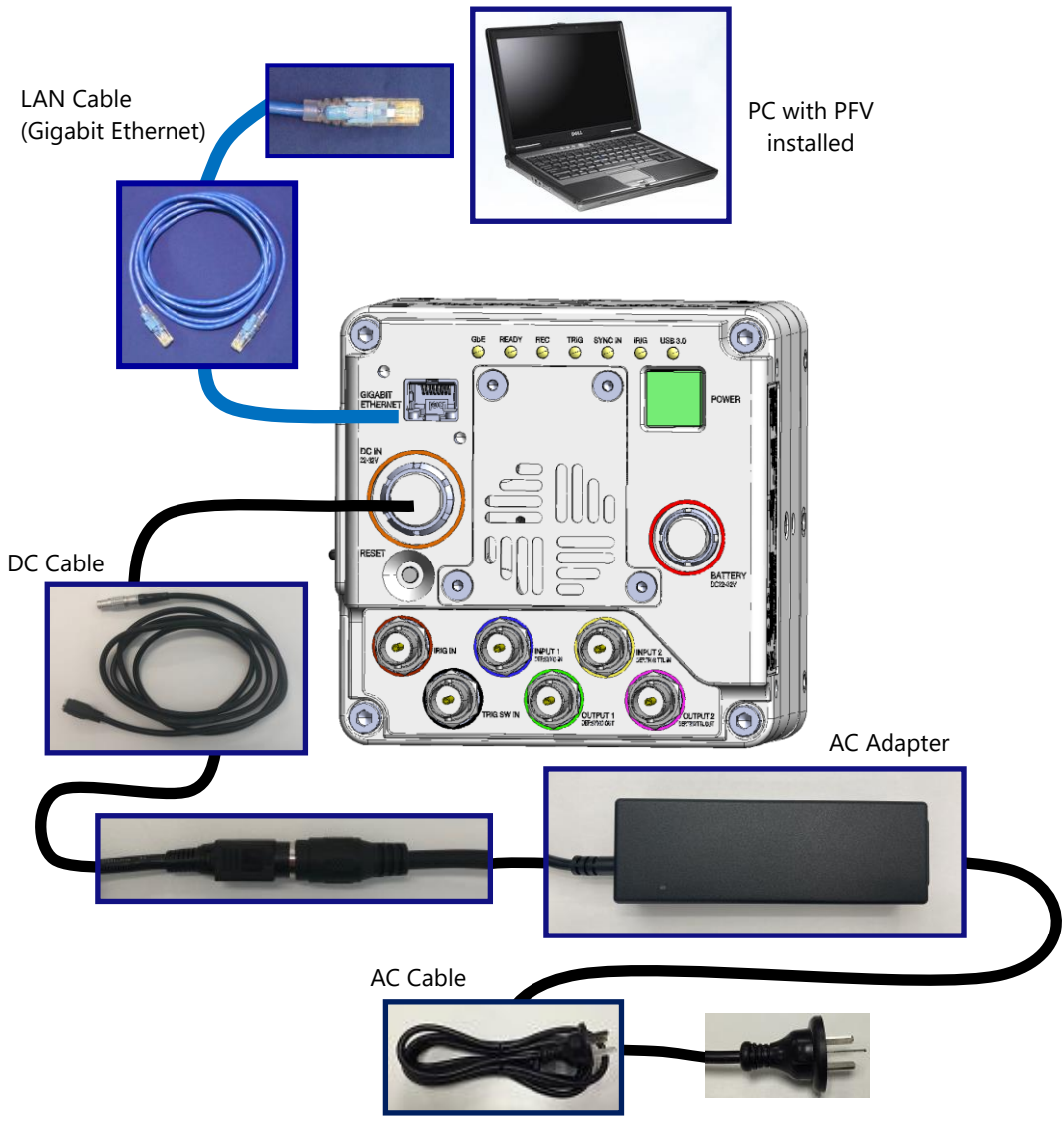

REFERENCE

Refer to “Photron FASTCAM Viewer 4 User’s Manual” for software operation.

1.4.2 Camera Hub (Optional)

The Camera Hub is a system for generating and distributing synchronization signals, distributing trigger signals, and supplying power to each camera simultaneously for systems that use multiple Photron high-speed cameras, such as for car crash testing.

The Camera Hub distributes synchronous signals and incoming trigger signals to each camera, while the Camera Hub supplies power to each camera to drive it.

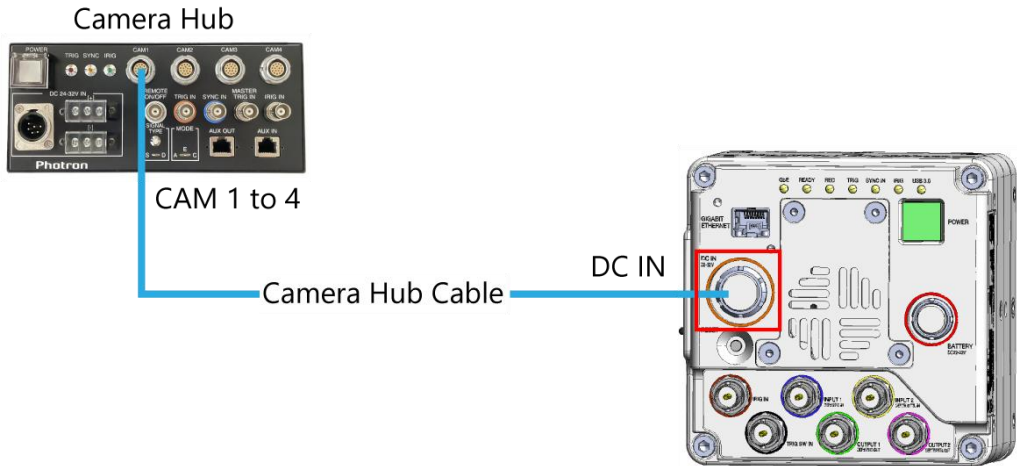

REFERENCE

For how to operate of the Camera Hub, refer to “Photron Camera Hub HW Manual”.

NOTE

The Camera Hub is optional. It is not included in the standard configuration.

1.4.3 Power Supply (DC Jack)

Power can be supplied from the camera by connecting the LED light or wireless module to the DC jack (center positive) on the side of the camera body.

The power supply can output 5 V/ Max. 1 A. When 5 V voltage is output, the LED above the terminal lights up.

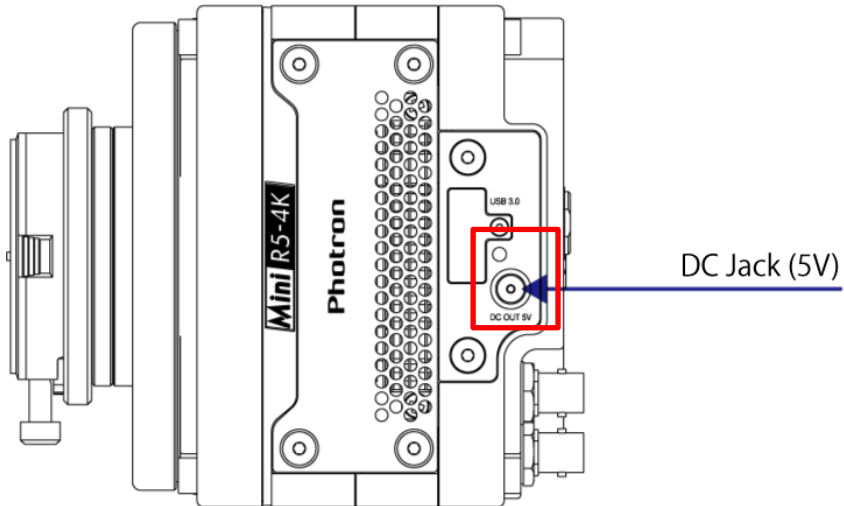

2

Chapter 2 Recording

This chapter explains operations related to recording.

2.1 Selecting Frame Rate / Resolution

◆ R3

Images can be recorded with the system from 60 fps to 750 fps using the full 4,096 x 2,304 pixels (9,437,184 pixels) resolution of the image sensor.

◆ R5

Images can be recorded with the system from 60 fps to 1,250 fps using the full 4,096 x 2,304 pixels (9,437,184 pixels) resolution of the image sensor.

For frame rates higher than the full frame rate, the high-speed recordings are achieved by restricting the readout area of the image sensor.

Restricting resolution enables higher speed recording. It also reduces data amount and then it enables longer time shooting/recording.



REFERENCE

For the detailed setting, refer to “3.1.5 Frame Rate and Resolution” on page 51.



NOTE

Automatic exposure control setting cannot be set for some frame rate / resolution combinations, or shutter speed tracking may be slow. Contact Photron for details.

2.1.1 Low Shutter Speed Mode

It is possible to configure the low shutter speed mode of below 60 fps (2 fps, 5 fps, 10 fps, 30 fps, 50 fps).

This mode is disabled as a default setting. Detailed configuration is possible when it is enabled. However, beware that the image quality lowers when this function is used.



REFERENCE

Refer to “10.7 Camera Option” of “Photron FASTCAM Viewer User’s Manual” for the details of the setup.

2.2 Selecting Shutter Speed

The shutter speed (Exposure time) is independent of the frame rate, and it is possible to control the exposure time in the frame using the electric shutter. By making an exposure that is of a shorter period than the frame rate, high-speed objects can be shot without blur.

◆ R3 / R5

The shortest setting value of shutter speed is 1/500,000 sec (approx 2.0 μ sec).



REFERENCE

- Refer to “4.3 Setting Shooting Conditions” of “Photron FASTCAM Viewer User’s Manual” for the details of the setup.
- For more information of Shutter Speed, refer to “3.1.8 Shutter Speed List” on page 62.

3

Chapter 3 Product Specifications

This chapter explains the system's specifications.

3.1 Specifications

3.1.1 Product Specifications

Image Sensor	CMOS image sensor		
Sensor Resolution	R3 / R5: 4,096 x 2,304 pixels		
Pixel Size	R3 / R5: 6.5 μ m square		
Frame Rate	For full frame R3: 750 fps R5: 1,250 fps	For Full HD 3,000 fps 5,280 fps	For segmented frame operation 150,000 fps maximum 200,000 fps maximum
Accuracy of frame rate	\pm 50 ppm		
Lens Mount	G type F mount, C mount (optional), EF mount (optional), M42 mount (optional)		
Recording Color Depth	Monochrome	12-bit	
	Color	RGB, each 12-bit (Bayer color filter method)	
Shutter Method	Electronic shutter (Global shutter)		
Recording Method	IC memory		
Recording Memory Capacity	8GB, 16GB, 32GB, 64GB		
Trigger Method	START, CENTER, END, MANUAL, RANDOM RESET, RANDOM MANUAL * Start, center and end triggers are supported by firmware version 5.1 or later and PFV4.3.0.0 or later.		
Gain Control	Controllable via software		
Image Output Customization	Customizable LUT, brightness is changeable		
External Synchronization Input Signal	+3.3 to +12 V, negative polarity / positive polarity (switchable)		
External Synchronization Output Signal	+5 V, negative polarity / positive polarity (switchable)		
Trigger Input Signal	TTL (+3.3 to +12V) negative polarity/positive polarity, contact		
Other Output Signals	Other timing signal outputs		
External Control	Gigabit Ethernet IF (PC)		
Digital Interface	RJ45 (1000BASE-T/10GBASE-T)		

3.1.2 General Specifications

Environment Conditions	
Storage Temperature	-20 to 60 deg C (No Condensation) -4 to 140 deg F (No Condensation)
Storage Humidity	85% or less (No Condensation)
Operating Temperature	0 to 40 deg C (No Condensation), 32 to 104 deg F (No Condensation)
Operating Humidity	80% or less (No Condensation)
High-G Capability	Firmware Ver. 2.1: 60 G, 10 msec, 6 axes, total 1,000 times Firmware Ver. 4.1 or later: 100 G, 10 msec, 6 axes, total 1,000 times
Pollution degree	Degree 2 according to IEC60664-1
Overvoltage category	Category II according to IEC60664-1
Maximum use altitude	2,000 m or lower
External Dimensions	
Camera Body	R3 / R5: 120.0 (H) x 120.0 (W) x 92.4 (D) mm, excluding protrusion 4.72" (H) x 4.72" (W) x 3.63" (D), excluding protrusion
DC Power Supply	
Power Voltage	22 V to 32 V
Power Consumption	70VA
Power Output (DC jack: Center positive)	
Supply voltage	5 V, Max. 1A output
Weight	
Camera Body	2.1 kg, 4.6 lbs



Photron has verified two types of AC cables, type A (standard for Japan, USA, Canada, etc.) and type SE (standard for Germany, France, etc.). However, when those cables cannot properly receive power when plugged in, use the proper AC cable for the region's standards and verify that AC cable works properly.

For inquiries regarding the recommended AC cable for each region, contact that region's Photron branch office or the distributor.

3.1.3 AC Adapter

Manufacturer		Adapter Technology Co., Ltd.
Type		ATS200TS-P240
Rating	Input	AC100-240V, 50-60Hz, up to 2.4A
	Output	DC24V, 8.3A
Dimensions		33.2 (H) x 54.2 (W) x 161.0 (D) mm excluding protrusions 1.30" (H) x 2.13" (W) x 6.33" (D)
Weight		0.56 kg, 1.23 lbs

3.1.4 Other Supported Function

Supported Function		
Variable Framerate/Resolution	Resolution Lock	Fan Control
Lens Control (optional)	IRIG Input	IRIG Synchronization
Variable Synchronization	Signal Delay Setting	Sync output rate Setting * ¹
Event Marker	Shutter Lock Mode	Signal Width Setting
Record While Save	Direct Start Setting	Stop Fan During Recording
Low Shutter Speed Function	Mechanical Shutter	Memory Partitioning (64)
IRIG Time Stamp's selection function at exposure start/end		

*¹ When using at the frame rate in the vicinity of the limit value when synchronizing the external device, the Sync output rate setting may be limited due to the error of the input frequency.



REFERENCE

Refer to “Photron FASTCAM Viewer 4 User’s Manual” for other functions.

3.1.5 Frame Rate and Resolution

◆ R3: 4,096 x 2,304 to 3,072 x 512

Resolution Frame Rate (fps)	4,096 x 2,304	4,096 x 1,504	4,096 x 1,024	4,096 x 512	4,096 x 256	4,096 x 128	4,096 x 64	4,096 x 32	4,096 x 16	4,096 x 8	3,840 x 2,160	3,072 x 2,304	3,072 x 1,600	3,072 x 1,024	3,072 x 512
60	✓	✓	✓	✓	✓	✓	✓	✓	✓	✓	✓	✓	✓	✓	✓
125	✓	✓	✓	✓	✓	✓	✓	✓	✓	✓	✓	✓	✓	✓	✓
250	✓	✓	✓	✓	✓	✓	✓	✓	✓	✓	✓	✓	✓	✓	✓
500	✓	✓	✓	✓	✓	✓	✓	✓	✓	✓	✓	✓	✓	✓	✓
750	✓	✓	✓	✓	✓	✓	✓	✓	✓	✓	✓	✓	✓	✓	✓
800		✓	✓	✓	✓	✓	✓	✓	✓	✓	✓	✓	✓	✓	✓
1,000		✓	✓	✓	✓	✓	✓	✓	✓	✓		✓	✓	✓	✓
1,250			✓	✓	✓	✓	✓	✓	✓	✓			✓	✓	✓
1,440			✓	✓	✓	✓	✓	✓	✓	✓				✓	✓
1,650			✓	✓	✓	✓	✓	✓	✓	✓				✓	✓
2,000				✓	✓	✓	✓	✓	✓	✓				✓	✓
2,500				✓	✓	✓	✓	✓	✓	✓					✓
3,000				✓	✓	✓	✓	✓	✓	✓					✓
4,000					✓	✓	✓	✓	✓	✓					✓
5,000					✓	✓	✓	✓	✓	✓					
5,500					✓	✓	✓	✓	✓	✓					
6,000					✓	✓	✓	✓	✓	✓					
8,000						✓	✓	✓	✓	✓					
10,000						✓	✓	✓	✓	✓					
12,000						✓	✓	✓	✓	✓					
15,000							✓	✓	✓	✓					
20,000							✓	✓	✓	✓					
25,000								✓	✓	✓					
33,000								✓	✓	✓					
40,000								✓	✓	✓					
50,000									✓	✓					
68,750									✓	✓					
72,000									✓	✓					
100,000										✓					
112,500															
120,000															
150,000															

The ✓ mark indicates a possible setting. Light blue items are the resolutions that will be selected first when you switch the frame rate.

This table shows default settings. Even finer settings are possible with the variable setting feature.

*The resolutions of the low shutter speed modes (2, 5, 10, 30 and 50 fps) are the same as 60 fps.

◆ R3: 3,072 x 256 to 2,048 x 16

Resolution Frame Rate (fps)	3,072 x 256	3,072 x 8	2,432 x 2,304	2,048 x 2,048	2,048 x 1,472	2,048 x 1,024	2,048 x 576	2,048 x 512	2,048 x 256	2,048 x 192	2,048 x 128	2,048 x 96	2,048 x 64	2,048 x 32	2,048 x 16
60	✓	✓	✓	✓	✓	✓	✓	✓	✓	✓	✓	✓	✓	✓	✓
125	✓	✓	✓	✓	✓	✓	✓	✓	✓	✓	✓	✓	✓	✓	✓
250	✓	✓	✓	✓	✓	✓	✓	✓	✓	✓	✓	✓	✓	✓	✓
500	✓	✓	✓	✓	✓	✓	✓	✓	✓	✓	✓	✓	✓	✓	✓
750	✓	✓	✓	✓	✓	✓	✓	✓	✓	✓	✓	✓	✓	✓	✓
800	✓	✓	✓	✓	✓	✓	✓	✓	✓	✓	✓	✓	✓	✓	✓
1,000	✓	✓	✓	✓	✓	✓	✓	✓	✓	✓	✓	✓	✓	✓	✓
1,250	✓	✓	✓	✓	✓	✓	✓	✓	✓	✓	✓	✓	✓	✓	✓
1,440	✓	✓		✓	✓	✓	✓	✓	✓	✓	✓	✓	✓	✓	✓
1,650	✓	✓		✓	✓	✓	✓	✓	✓	✓	✓	✓	✓	✓	✓
2,000	✓	✓			✓	✓	✓	✓	✓	✓	✓	✓	✓	✓	✓
2,500	✓	✓				✓	✓	✓	✓	✓	✓	✓	✓	✓	✓
3,000	✓	✓				✓	✓	✓	✓	✓	✓	✓	✓	✓	✓
4,000	✓	✓					✓	✓	✓	✓	✓	✓	✓	✓	✓
5,000	✓	✓					✓	✓	✓	✓	✓	✓	✓	✓	✓
5,500	✓	✓					✓	✓	✓	✓	✓	✓	✓	✓	✓
6,000	✓	✓						✓	✓	✓	✓	✓	✓	✓	✓
8,000	✓	✓							✓	✓	✓	✓	✓	✓	✓
10,000	✓	✓							✓	✓	✓	✓	✓	✓	✓
12,000		✓							✓	✓	✓	✓	✓	✓	✓
15,000		✓								✓	✓	✓	✓	✓	✓
20,000		✓									✓	✓	✓	✓	✓
25,000		✓										✓	✓	✓	✓
33,000		✓											✓	✓	✓
40,000		✓											✓	✓	✓
50,000		✓												✓	✓
68,750		✓												✓	✓
72,000		✓												✓	✓
100,000		✓													✓
112,500		✓													✓
120,000		✓													
150,000															

The ✓ mark indicates a possible setting. Light blue items are the resolutions that will be selected first when you switch the frame rate.

This table shows default settings. Even finer settings are possible with the variable setting feature.

*The resolutions of the low shutter speed modes (2, 5, 10, 30 and 50 fps) are the same as 60 fps.

◆ R3: 2,048 x 8 to 128 x 8

Resolution Frame Rate (fps)	2,048 x 8	1,920 x 1,080	1,280 x 720	1,024 x 1,024	1,024 x 512	1,024 x 256	1,024 x 8	640 x 480	512 x 512	512 x 256	256 x 256	128 x 128	128 x 32	128 x 16	128 x 8
60	✓	✓	✓	✓	✓	✓	✓	✓	✓	✓	✓	✓	✓	✓	✓
125	✓	✓	✓	✓	✓	✓	✓	✓	✓	✓	✓	✓	✓	✓	✓
250	✓	✓	✓	✓	✓	✓	✓	✓	✓	✓	✓	✓	✓	✓	✓
500	✓	✓	✓	✓	✓	✓	✓	✓	✓	✓	✓	✓	✓	✓	✓
750	✓	✓	✓	✓	✓	✓	✓	✓	✓	✓	✓	✓	✓	✓	✓
800	✓	✓	✓	✓	✓	✓	✓	✓	✓	✓	✓	✓	✓	✓	✓
1,000	✓	✓	✓	✓	✓	✓	✓	✓	✓	✓	✓	✓	✓	✓	✓
1,250	✓	✓	✓	✓	✓	✓	✓	✓	✓	✓	✓	✓	✓	✓	✓
1,440	✓	✓	✓	✓	✓	✓	✓	✓	✓	✓	✓	✓	✓	✓	✓
1,650	✓	✓	✓	✓	✓	✓	✓	✓	✓	✓	✓	✓	✓	✓	✓
2,000	✓	✓	✓	✓	✓	✓	✓	✓	✓	✓	✓	✓	✓	✓	✓
2,500	✓	✓	✓	✓	✓	✓	✓	✓	✓	✓	✓	✓	✓	✓	✓
3,000	✓	✓	✓	✓	✓	✓	✓	✓	✓	✓	✓	✓	✓	✓	✓
4,000	✓		✓		✓	✓	✓	✓	✓	✓	✓	✓	✓	✓	✓
5,000	✓				✓	✓	✓	✓	✓	✓	✓	✓	✓	✓	✓
5,500	✓				✓	✓	✓	✓	✓	✓	✓	✓	✓	✓	✓
6,000	✓				✓	✓	✓	✓	✓	✓	✓	✓	✓	✓	✓
8,000	✓					✓	✓			✓	✓	✓	✓	✓	✓
10,000	✓					✓	✓			✓	✓	✓	✓	✓	✓
12,000	✓					✓	✓			✓	✓	✓	✓	✓	✓
15,000	✓						✓					✓	✓	✓	✓
20,000	✓						✓					✓	✓	✓	✓
25,000	✓						✓						✓	✓	✓
33,000	✓						✓						✓	✓	✓
40,000	✓						✓						✓	✓	✓
50,000	✓						✓						✓	✓	✓
68,750	✓						✓						✓	✓	✓
72,000	✓						✓							✓	✓
100,000	✓						✓							✓	✓
112,500	✓						✓							✓	✓
120,000	✓						✓								✓
150,000	✓						✓								✓

The ✓ mark indicates a possible setting. Light blue items are the resolutions that will be selected first when you switch the frame rate.

This table shows default settings. Even finer settings are possible with the variable setting feature.

*The resolutions of the low shutter speed modes (2, 5, 10, 30 and 50 fps) are the same as 60 fps.

◆ R5: 4,096 x 2,304 to 3,072 x 512

Resolution Frame Rate (fps)	4,096 x 2,304	4,096 x 1,504	4,096 x 1,024	4,096 x 512	4,096 x 256	4,096 x 128	4,096 x 64	4,096 x 32	4,096 x 16	4,096 x 8	3,840 x 2,160	3,072 x 2,304	3,072 x 1,600	3,072 x 1,024	3,072 x 512
60	✓	✓	✓	✓	✓	✓	✓	✓	✓	✓	✓	✓	✓	✓	✓
125	✓	✓	✓	✓	✓	✓	✓	✓	✓	✓	✓	✓	✓	✓	✓
250	✓	✓	✓	✓	✓	✓	✓	✓	✓	✓	✓	✓	✓	✓	✓
500	✓	✓	✓	✓	✓	✓	✓	✓	✓	✓	✓	✓	✓	✓	✓
750	✓	✓	✓	✓	✓	✓	✓	✓	✓	✓	✓	✓	✓	✓	✓
800	✓	✓	✓	✓	✓	✓	✓	✓	✓	✓	✓	✓	✓	✓	✓
1,000	✓	✓	✓	✓	✓	✓	✓	✓	✓	✓	✓	✓	✓	✓	✓
1,250	✓	✓	✓	✓	✓	✓	✓	✓	✓	✓	✓	✓	✓	✓	✓
1,440		✓	✓	✓	✓	✓	✓	✓	✓	✓	✓	✓	✓	✓	✓
1,650		✓	✓	✓	✓	✓	✓	✓	✓	✓		✓	✓	✓	✓
2,000		✓*	✓	✓	✓	✓	✓	✓	✓	✓			✓	✓	✓
2,500			✓	✓	✓	✓	✓	✓	✓	✓			✓	✓	✓
2,880			✓	✓	✓	✓	✓	✓	✓	✓				✓	✓
3,000				✓	✓	✓	✓	✓	✓	✓				✓	✓
3,750				✓	✓	✓	✓	✓	✓	✓				✓	✓
4,000				✓	✓	✓	✓	✓	✓	✓					✓
5,000				✓	✓	✓	✓	✓	✓	✓					✓
5,280				✓	✓	✓	✓	✓	✓	✓					✓
5,500				✓	✓	✓	✓	✓	✓	✓					✓
6,000					✓	✓	✓	✓	✓	✓					✓
7,500					✓	✓	✓	✓	✓	✓					✓
8,000					✓	✓	✓	✓	✓	✓					
10,000					✓	✓	✓	✓	✓	✓					
11,250					✓	✓	✓	✓	✓	✓					
12,000						✓	✓	✓	✓	✓					
15,000						✓	✓	✓	✓	✓					
20,000						✓	✓	✓	✓	✓					
25,000							✓	✓	✓	✓					
33,000							✓	✓	✓	✓					
40,000							✓	✓	✓	✓					
50,000								✓	✓	✓					
68,750								✓	✓	✓					
72,000									✓	✓					
100,000									✓	✓					
112,500										✓					
120,000										✓					
150,000										✓					
158,400															
165,000															
187,500															
200,000															

The ✓ mark indicates a possible setting. Light blue items are the resolutions that will be selected first when you switch the frame rate.

This table shows default settings. Even finer settings are possible with the variable setting feature.

*The resolutions of the low shutter speed modes (2, 5, 10, 30 and 50 fps) are the same as 60 fps.

◆ R5: 3,072 x 256 to 2,048 x 192

Resolution Frame Rate (fps)	3,072 x 256	3,072 x 8	2,432 x 2,304	2,048 x 2,048	2,048 x 1,952	2,048 x 1,472	2,048 x 1,152	2,048 x 1,024	2,048 x 960	2,048 x 704	2,048 x 576	2,048 x 512	2,048 x 480	2,048 x 256	2,048 x 192
60	✓	✓	✓	✓	✓	✓	✓	✓	✓	✓	✓	✓	✓	✓	✓
125	✓	✓	✓	✓	✓	✓	✓	✓	✓	✓	✓	✓	✓	✓	✓
250	✓	✓	✓	✓	✓	✓	✓	✓	✓	✓	✓	✓	✓	✓	✓
500	✓	✓	✓	✓	✓	✓	✓	✓	✓	✓	✓	✓	✓	✓	✓
750	✓	✓	✓	✓	✓	✓	✓	✓	✓	✓	✓	✓	✓	✓	✓
800	✓	✓	✓	✓	✓	✓	✓	✓	✓	✓	✓	✓	✓	✓	✓
1,000	✓	✓	✓	✓	✓	✓	✓	✓	✓	✓	✓	✓	✓	✓	✓
1,250	✓	✓	✓	✓	✓	✓	✓	✓	✓	✓	✓	✓	✓	✓	✓
1,440	✓	✓	✓	✓	✓	✓	✓	✓	✓	✓	✓	✓	✓	✓	✓
1,650	✓	✓	✓	✓	✓	✓	✓	✓	✓	✓	✓	✓	✓	✓	✓
2,000	✓	✓	✓	✓	✓	✓	✓	✓	✓	✓	✓	✓	✓	✓	✓
2,500	✓	✓	✓	✓	✓	✓	✓	✓	✓	✓	✓	✓	✓	✓	✓
2,880	✓	✓	✓	✓	✓	✓	✓	✓	✓	✓	✓	✓	✓	✓	✓
3,000	✓	✓	✓	✓	✓	✓	✓	✓	✓	✓	✓	✓	✓	✓	✓
3,750	✓	✓	✓	✓	✓	✓	✓	✓	✓	✓	✓	✓	✓	✓	✓
4,000	✓	✓	✓	✓	✓	✓	✓	✓	✓	✓	✓	✓	✓	✓	✓
5,000	✓	✓	✓	✓	✓	✓	✓	✓	✓	✓	✓	✓	✓	✓	✓
5,280	✓	✓	✓	✓	✓	✓	✓	✓	✓	✓	✓	✓	✓	✓	✓
5,500	✓	✓	✓	✓	✓	✓	✓	✓	✓	✓	✓	✓	✓	✓	✓
6,000	✓	✓	✓	✓	✓	✓	✓	✓	✓	✓	✓	✓	✓	✓	✓
7,500	✓	✓	✓	✓	✓	✓	✓	✓	✓	✓	✓	✓	✓	✓	✓
8,000	✓	✓	✓	✓	✓	✓	✓	✓	✓	✓	✓	✓	✓	✓	✓
10,000	✓	✓	✓	✓	✓	✓	✓	✓	✓	✓	✓	✓	✓	✓	✓
11,250	✓	✓	✓	✓	✓	✓	✓	✓	✓	✓	✓	✓	✓	✓	✓
12,000	✓	✓	✓	✓	✓	✓	✓	✓	✓	✓	✓	✓	✓	✓	✓
15,000	✓	✓	✓	✓	✓	✓	✓	✓	✓	✓	✓	✓	✓	✓	✓
20,000	✓	✓	✓	✓	✓	✓	✓	✓	✓	✓	✓	✓	✓	✓	✓
25,000	✓	✓	✓	✓	✓	✓	✓	✓	✓	✓	✓	✓	✓	✓	✓
33,000	✓	✓	✓	✓	✓	✓	✓	✓	✓	✓	✓	✓	✓	✓	✓
40,000	✓	✓	✓	✓	✓	✓	✓	✓	✓	✓	✓	✓	✓	✓	✓
50,000	✓	✓	✓	✓	✓	✓	✓	✓	✓	✓	✓	✓	✓	✓	✓
68,750	✓	✓	✓	✓	✓	✓	✓	✓	✓	✓	✓	✓	✓	✓	✓
72,000	✓	✓	✓	✓	✓	✓	✓	✓	✓	✓	✓	✓	✓	✓	✓
100,000	✓	✓	✓	✓	✓	✓	✓	✓	✓	✓	✓	✓	✓	✓	✓
112,500	✓	✓	✓	✓	✓	✓	✓	✓	✓	✓	✓	✓	✓	✓	✓
120,000	✓	✓	✓	✓	✓	✓	✓	✓	✓	✓	✓	✓	✓	✓	✓
150,000	✓	✓	✓	✓	✓	✓	✓	✓	✓	✓	✓	✓	✓	✓	✓
158,400	✓	✓	✓	✓	✓	✓	✓	✓	✓	✓	✓	✓	✓	✓	✓
165,000	✓	✓	✓	✓	✓	✓	✓	✓	✓	✓	✓	✓	✓	✓	✓
187,500	✓	✓	✓	✓	✓	✓	✓	✓	✓	✓	✓	✓	✓	✓	✓
200,000	✓	✓	✓	✓	✓	✓	✓	✓	✓	✓	✓	✓	✓	✓	✓

The ✓ mark indicates a possible setting. Light blue items are the resolutions that will be selected first when you switch the frame rate.

This table shows default settings. Even finer settings are possible with the variable setting feature.

*The resolutions of the low shutter speed modes (2, 5, 10, 30 and 50 fps) are the same as 60 fps.

◆ R5: 2,048 x 160 to 512 x 512

Resolution Frame Rate (fps)	2,048 x 160	2,048 x 128	2,048 x 96	2,048 x 64	2,048 x 32	2,048 x 16	2,048 x 8	1,920 x 1,080	1,280 x 720	1,024 x 1,024	1,024 x 512	1,024 x 256	1,024 x 8	640 x 480	512 x 512
60	✓	✓	✓	✓	✓	✓	✓	✓	✓	✓	✓	✓	✓	✓	✓
125	✓	✓	✓	✓	✓	✓	✓	✓	✓	✓	✓	✓	✓	✓	✓
250	✓	✓	✓	✓	✓	✓	✓	✓	✓	✓	✓	✓	✓	✓	✓
500	✓	✓	✓	✓	✓	✓	✓	✓	✓	✓	✓	✓	✓	✓	✓
750	✓	✓	✓	✓	✓	✓	✓	✓	✓	✓	✓	✓	✓	✓	✓
800	✓	✓	✓	✓	✓	✓	✓	✓	✓	✓	✓	✓	✓	✓	✓
1,000	✓	✓	✓	✓	✓	✓	✓	✓	✓	✓	✓	✓	✓	✓	✓
1,250	✓	✓	✓	✓	✓	✓	✓	✓	✓	✓	✓	✓	✓	✓	✓
1,440	✓	✓	✓	✓	✓	✓	✓	✓	✓	✓	✓	✓	✓	✓	✓
1,650	✓	✓	✓	✓	✓	✓	✓	✓	✓	✓	✓	✓	✓	✓	✓
2,000	✓	✓	✓	✓	✓	✓	✓	✓	✓	✓	✓	✓	✓	✓	✓
2,500	✓	✓	✓	✓	✓	✓	✓	✓	✓	✓	✓	✓	✓	✓	✓
2,880	✓	✓	✓	✓	✓	✓	✓	✓	✓	✓	✓	✓	✓	✓	✓
3,000	✓	✓	✓	✓	✓	✓	✓	✓	✓	✓	✓	✓	✓	✓	✓
3,750	✓	✓	✓	✓	✓	✓	✓	✓	✓	✓	✓	✓	✓	✓	✓
4,000	✓	✓	✓	✓	✓	✓	✓	✓	✓	✓	✓	✓	✓	✓	✓
5,000	✓	✓	✓	✓	✓	✓	✓	✓	✓	✓	✓	✓	✓	✓	✓
5,280	✓	✓	✓	✓	✓	✓	✓	✓	✓	✓	✓	✓	✓	✓	✓
5,500	✓	✓	✓	✓	✓	✓	✓	✓	✓	✓	✓	✓	✓	✓	✓
6,000	✓	✓	✓	✓	✓	✓	✓	✓	✓	✓	✓	✓	✓	✓	✓
7,500	✓	✓	✓	✓	✓	✓	✓	✓	✓	✓	✓	✓	✓	✓	✓
8,000	✓	✓	✓	✓	✓	✓	✓	✓	✓	✓	✓	✓	✓	✓	✓
10,000	✓	✓	✓	✓	✓	✓	✓	✓	✓	✓	✓	✓	✓	✓	✓
11,250	✓	✓	✓	✓	✓	✓	✓	✓	✓	✓	✓	✓	✓	✓	✓
12,000	✓	✓	✓	✓	✓	✓	✓	✓	✓	✓	✓	✓	✓	✓	✓
15,000	✓	✓	✓	✓	✓	✓	✓	✓	✓	✓	✓	✓	✓	✓	✓
20,000	✓	✓	✓	✓	✓	✓	✓	✓	✓	✓	✓	✓	✓	✓	✓
25,000	✓	✓	✓	✓	✓	✓	✓	✓	✓	✓	✓	✓	✓	✓	✓
33,000	✓	✓	✓	✓	✓	✓	✓	✓	✓	✓	✓	✓	✓	✓	✓
40,000	✓	✓	✓	✓	✓	✓	✓	✓	✓	✓	✓	✓	✓	✓	✓
50,000	✓	✓	✓	✓	✓	✓	✓	✓	✓	✓	✓	✓	✓	✓	✓
68,750	✓	✓	✓	✓	✓	✓	✓	✓	✓	✓	✓	✓	✓	✓	✓
72,000	✓	✓	✓	✓	✓	✓	✓	✓	✓	✓	✓	✓	✓	✓	✓
100,000	✓	✓	✓	✓	✓	✓	✓	✓	✓	✓	✓	✓	✓	✓	✓
112,500	✓	✓	✓	✓	✓	✓	✓	✓	✓	✓	✓	✓	✓	✓	✓
120,000	✓	✓	✓	✓	✓	✓	✓	✓	✓	✓	✓	✓	✓	✓	✓
150,000	✓	✓	✓	✓	✓	✓	✓	✓	✓	✓	✓	✓	✓	✓	✓
158,400	✓	✓	✓	✓	✓	✓	✓	✓	✓	✓	✓	✓	✓	✓	✓
165,000	✓	✓	✓	✓	✓	✓	✓	✓	✓	✓	✓	✓	✓	✓	✓
187,500	✓	✓	✓	✓	✓	✓	✓	✓	✓	✓	✓	✓	✓	✓	✓
200,000	✓	✓	✓	✓	✓	✓	✓	✓	✓	✓	✓	✓	✓	✓	✓

The ✓ mark indicates a possible setting. Light blue items are the resolutions that will be selected first when you switch the frame rate.

This table shows default settings. Even finer settings are possible with the variable setting feature.

*The resolutions of the low shutter speed modes (2, 5, 10, 30 and 50 fps) are the same as 60 fps.

◆ R5: 512 x 256 to 128 x 8

Resolution Frame Rate (fps)	512 x 256	256 x 256	128 x 128	128 x 32	128 x 16	128 x 8
60	✓	✓	✓	✓	✓	✓
125	✓	✓	✓	✓	✓	✓
250	✓	✓	✓	✓	✓	✓
500	✓	✓	✓	✓	✓	✓
750	✓	✓	✓	✓	✓	✓
800	✓	✓	✓	✓	✓	✓
1,000	✓	✓	✓	✓	✓	✓
1,250	✓	✓	✓	✓	✓	✓
1,440	✓	✓	✓	✓	✓	✓
1,650	✓	✓	✓	✓	✓	✓
2,000	✓	✓	✓	✓	✓	✓
2,500	✓	✓	✓	✓	✓	✓
2,880	✓	✓	✓	✓	✓	✓
3,000	✓	✓	✓	✓	✓	✓
3,750	✓	✓	✓	✓	✓	✓
4,000	✓	✓	✓	✓	✓	✓
5,000	✓	✓	✓	✓	✓	✓
5,280	✓	✓	✓	✓	✓	✓
5,500	✓	✓	✓	✓	✓	✓
6,000	✓	✓	✓	✓	✓	✓
7,500	✓	✓	✓	✓	✓	✓
8,000	✓	✓	✓	✓	✓	✓
10,000	✓	✓	✓	✓	✓	✓
11,250	✓	✓	✓	✓	✓	✓
12,000	✓	✓	✓	✓	✓	✓
15,000	✓	✓	✓	✓	✓	✓
20,000	✓	✓	✓	✓	✓	✓
25,000			✓	✓	✓	✓
33,000			✓	✓	✓	✓
40,000			✓	✓	✓	✓
50,000				✓	✓	✓
68,750				✓	✓	✓
72,000				✓	✓	✓
100,000				✓	✓	✓
112,500				✓	✓	✓
120,000					✓	✓
150,000					✓	✓
158,400					✓	✓
165,000					✓	✓
187,500						✓
200,000						✓

The ✓ mark indicates a possible setting. Light blue items are the resolutions that will be selected first when you switch the frame rate.

This table shows default settings. Even finer settings are possible with the variable setting feature.

*The resolutions of the low shutter speed modes (2, 5, 10, 30 and 50 fps) are the same as 60 fps.

3.1.6 Recordable Frames / Resolution

◆ R3

Resolution	8GB Model Rec. Frames	16GB Model Rec. Frames	32GB Model Rec. Frames	64GB Model Rec. Frames
4,096 x 2,304	600	1,207	2,421	4,848
4,096 x 1,024	1,351	2,717	5,447	10,909
3,840 x 2,160	683	1374	2754	5516
3,072 x 2,304	801	1,610	3,228	6,464
3,072 x 1,600	1,153	2,318	4,648	9,309
3,072 x 1,024	1,802	3,622	7,263	14,545
2,432 x 2,304	1,011	2,033	4,077	8,165
2,048 x 2,048	1,351	2,717	5,447	10,909
2,048 x 1,024	2,703	5,434	10,895	21,818
2,048 x 512	5,407	10,868	21,791	43,636
1,920 x 1,080	2,734	5,496	11,019	22,066
1,024 x 1,024	5,407	10,868	21,791	43,636
1,024 x 512	10,814	21,737	43,582	87,273
1,024 x 256	21,629	43,474	87,165	174,546
640 x 480	18,457	37,098	74,381	148,946
512 x 512	21,629	43,474	87,165	174,546
512 x 256	43,258	86,949	174,330	349,093
256 x 256	86,517	173,898	348,661	698,186
128 x 128	346,069	695,594	1,394,645	2,792,746
128 x 32	1,384,277	2,782,378	5,578,581	11,170,986

* Recording Time = Rec. Frames x 1/frame rate (fps)

 **NOTE**

Contact Photron for the recordable frames for other resolutions.

◆ R5

Resolution	8GB Model Rec. Frames	16GB Model Rec. Frames	32GB Model Rec. Frames	64GB Model Rec. Frames
4,096 x 2,304	600	1207	2,421	4,848
4,096 x 1,024	1,351	2,717	5,447	10,909
3,840 x 2,160	683	1374	2754	5516
3,072 x 2,304	801	1,610	3,228	6,464
3,072 x 1,600	1,153	2,318	4,648	9,309
3,072 x 1,024	1,802	3,622	7,263	14,545
2,432 x 2,304	1,011	2,033	4,077	8,165
2,048 x 2,048	1,351	2,717	5,447	10,909
2,048 x 1,024	2,703	5,434	10,895	21,818
2,048 x 512	5,407	10,868	21,791	43,636
1,920 x 1,080	2,734	5,496	11,019	22,066
1,024 x 1,024	5,407	10,868	21,791	43,636
1,024 x 512	10,814	21,737	43,582	87,273
1,024 x 256	21,629	43,474	87,165	174,546
512 x 512	21,629	43,474	87,165	174,546
512 x 256	43,258	86,949	174,330	349,093
256 x 256	86,517	173,898	348,661	698,186
128 x 128	346,069	695,594	1,394,645	2,792,746
128 x 32	1,384,277	2,782,378	5,578,581	11,170,986

* Recording Time = Rec. Frames x 1/frame rate (fps)

 **NOTE**

Contact Photron for the recordable frames for other resolutions.

3.1.7 Recordable Time / Resolution

◆ R3

Resolution	Max Framerate	8GB Model Rec. Time	16GB Model Rec. Time	32GB Model Rec. Time	64GB Model Rec. Time
4,096 x 2,304	750	0.800	1.609	3.228	6.464
4,096 x 1,024	1,650	0.819	1.647	3.301	6.612
3,840 x 2,160	800	0.854	1.718	3.443	6.895
3,072 x 2,304	1,000	0.801	1.610	3.228	6.464
3,072 x 1,600	1,250	0.922	1.854	3.718	7.447
3,072 x 1,024	2,000	0.901	1.811	3.632	7.273
2,432 x 2,304	1,250	0.809	1.626	3.262	6.532
2,048 x 2,048	1,650	0.819	1.647	3.301	6.612
2,048 x 1,024	3,000	0.901	1.811	3.632	7.273
2,048 x 512	6,000	0.901	1.811	3.632	7.273
1,920 x 1,080	3,000	0.911	1.832	3.673	7.355
1,024 x 1,024	3,000	1.802	3.623	7.264	14.545
1,024 x 512	6,000	1.802	3.623	7.264	14.546
1,024 x 256	12,000	1.802	3.623	7.264	14.546
640 x 480	6,000	3.076	6.183	12.397	24.824
512 x 512	6,000	3.605	7.246	14.528	29.091
512 x 256	12,000	3.605	7.246	14.528	29.091
256 x 256	12,000	7.210	14.492	29.055	58.182
128 x 128	20,000	17.303	34.780	69.732	139.637
128 x 32	68,750	20.135	40.471	81.143	162.487

The unit in the chart is seconds.

 **NOTE**

Contact Photron for the recordable time for other resolutions.

◆ R5

Resolution	Max Framerate	8GB Model Rec. Time	16GB Model Rec. Time	32GB Model Rec. Time	64GB Model Rec. Time
4,096 x 2,304	1,250	0.480	0.966	1.937	3.878
4,096 x 1,024	2,880	0.469	0.943	1.891	3.788
3,840 x 2,160	1,440	0.474	0.954	1.913	3.831
3,072 x 2,304	1,650	0.485	0.976	1.956	3.918
3,072 x 1,600	2,500	0.461	0.927	1.859	3.724
3,072 x 1,024	3,750	0.481	0.966	1.937	3.879
2,432 x 2,304	2,000	0.506	1.017	2.039	4.083
2,048 x 2,048	2,880	0.469	0.943	1.891	3.788
2,048 x 1,024	5,500	0.491	0.988	1.981	3.967
2,048 x 512	11,250	0.481	0.966	1.937	3.879
1,920 x 1,080	5,280	0.518	1.041	2.087	4.179
1,024 x 1,024	5,500	0.983	1.976	3.962	7.933
1,024 x 512	11,250	0.961	1.932	3.874	7.758
1,024 x 256	20,000	1.081	2.174	4.358	8.727
512 x 512	11,250	1.923	3.864	7.748	15.515
512 x 256	20,000	2.163	4.347	8.717	17.455
256 x 256	20,000	4.326	8.695	17.433	34.909
128 x 128	40,000	8.652	17.390	34.866	69.819
128 x 32	112,500	12.305	24.732	49.587	99.298

The unit in the chart is seconds.

 **NOTE**

Contact Photron for the recordable time for other resolutions.

3.1.8 Shutter Speed List

◆ R3 / R5

- 1/frame sec
- 1/50 sec*
- 1/60 sec *
- 1/100 sec *
- 1/200 sec
- 1/300 sec
- 1/400 sec
- 1/500 sec
- 1/600 sec
- 1/700 sec
- 1/800 sec
- 1/900 sec
- 1/1,000 sec
- 1/2,000 sec
- 1/3,000 sec
- 1/4,000 sec
- 1/5,000 sec
- 1/6,000 sec
- 1/7,000 sec
- 1/8,000 sec
- 1/9,000 sec
- 1/10,000 sec
- 1/12,000 sec
- 1/15,000 sec
- 1/17,000 sec
- 1/20,000 sec
- 1/25,000 sec
- 1/30,000 sec
- 1/35,000 sec
- 1/40,000 sec
- 1/50,000 sec
- 1/60,000 sec
- 1/70,000 sec
- 1/80,000 sec
- 1/90,000 sec
- 1/100,000 sec
- 1/124,000 sec
- 1/200,000 sec
- 1/250,000 sec
- 1/280,000 sec
- 1/300,000 sec
- 1/360,000 sec
- 1/400,000 sec
- 1/500,000 sec

* 1/50sec, 1/60sec, and 1/100sec can be selected when the “Low Shutter Speed Mode” is enabled. For details, refer to the “2.1.1 Low Shutter Speed Mode” on page 45.

3.1.9 Random Reset Delay / Inter Frame Time

With the random reset trigger mode, the exposure starts after a certain delay from the trigger input. This delay from the trigger input is referred to as the “Random Reset Delay”.

In addition, when the shutter speed is set to 1/frame, the shutter is always open numerically, but due to the characteristics of electronic shutters, a reset time is required and there is a small period of time when no exposure occurs. This time is referred to as “Inter Frame Time”.

The Inter Frame Time occurs only at 1/frame and does not occur when the shutter is released.

This time can also be checked by setting the shutter speed display to “0.xxx msec” setting in PFV4.

The Random Reset Delay and Inter Frame Time of this system are shown in the timing diagram below and vary depending on the specific frame rate and resolution conditions.

Refer to the two tables on the next page for specific values.

■ Overview diagrams of Inter Frame Time and Random Reset Delay

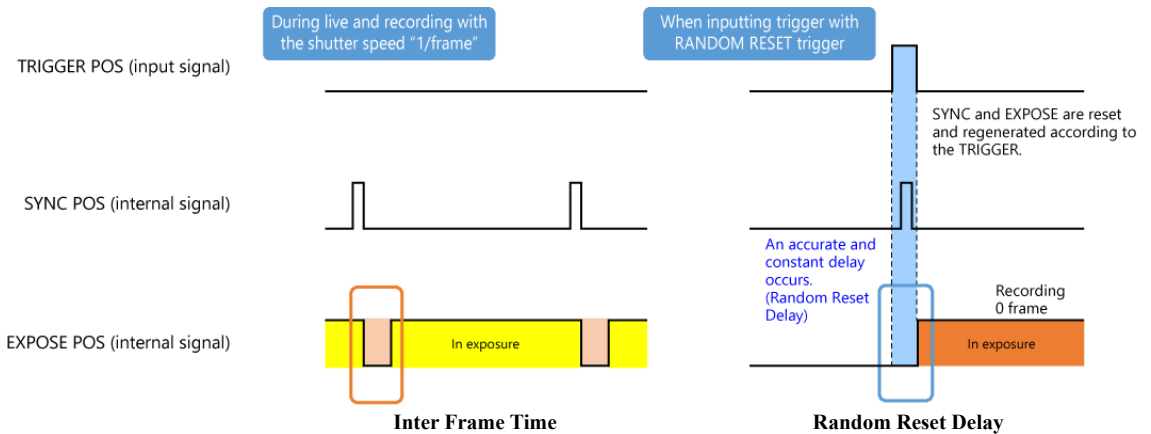

■ Enlarged diagrams of Inter Frame Time and Random Reset Delay

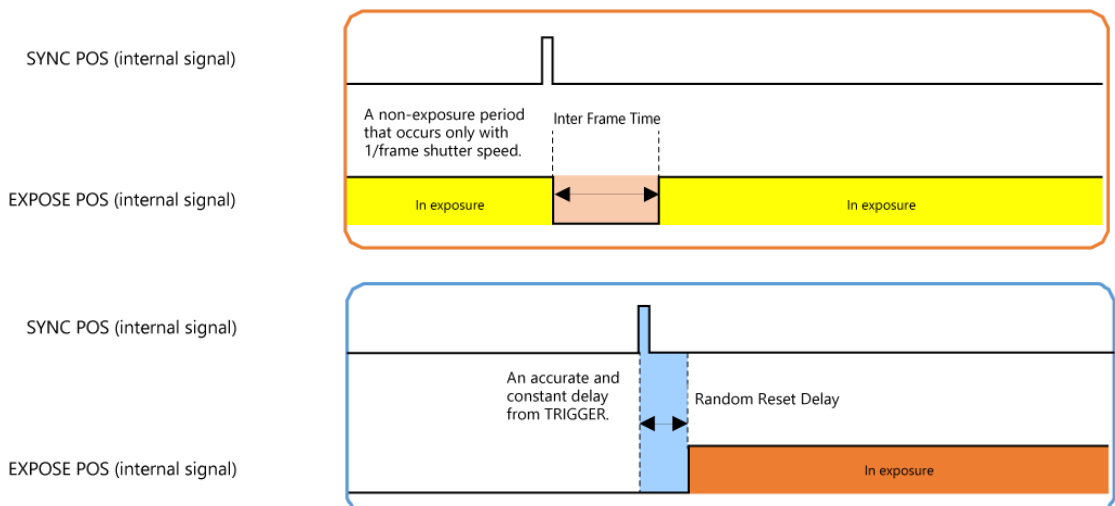

■ Values for each frame rate and resolution condition

◆ R3 / R5

Random Reset Delay	Inter Frame Time
1168.6 nsec to 11700 nsec	2.84 μ sec



CAUTION

During random reset recording, trigger from either PFV or external input. If trigger is input from both, malfunction may occur.

3.2 Dimensions

3.2.1 Camera Body

◆ FASTCAM Mini R3 / R5 (G type F mount) (mm)

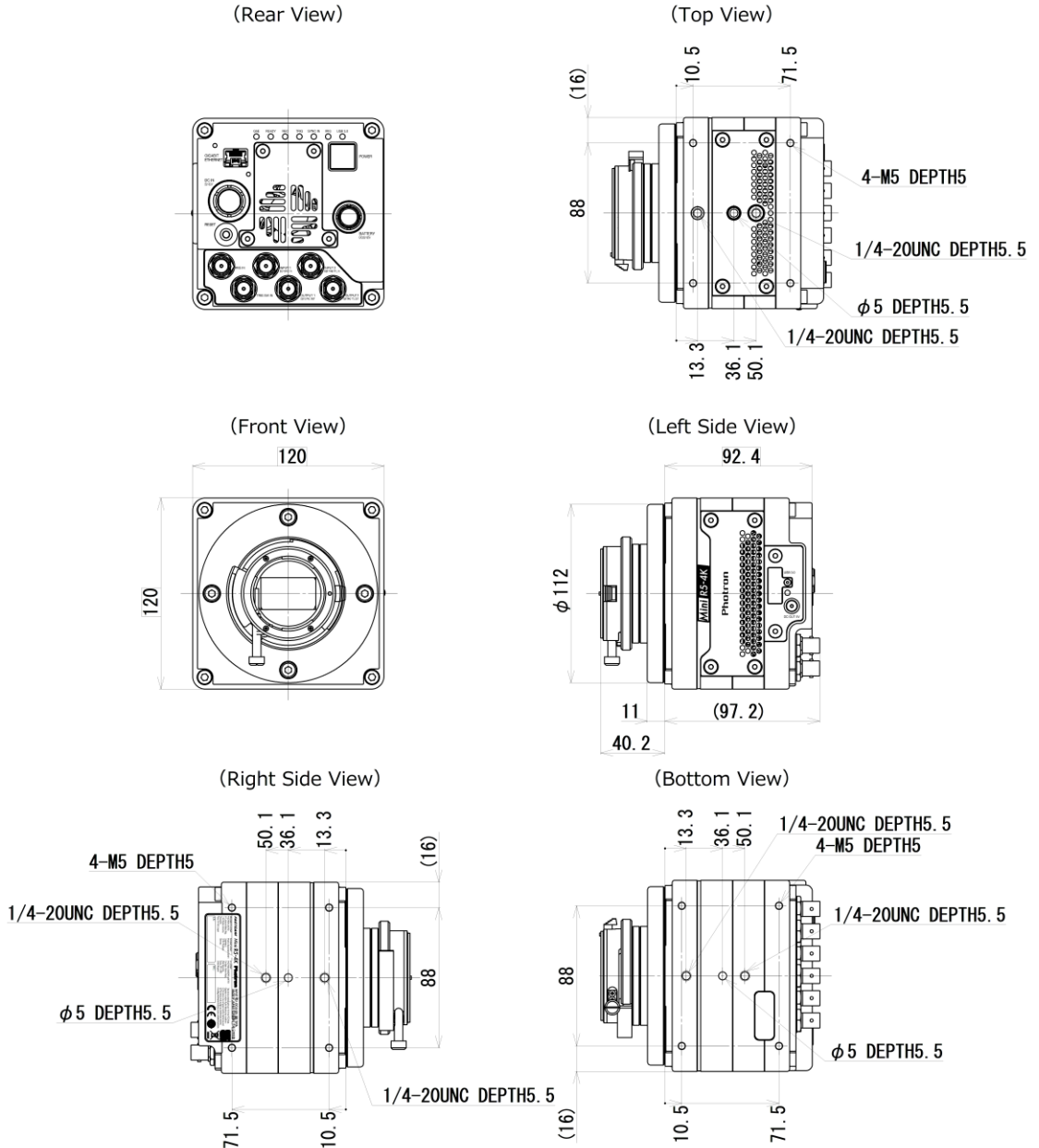

*** Caution**
 If a screw that is longer than the specified length is forced into the hole, the screw hole and/or the camera may be damaged.

◆ FASTCAM Mini R3 / R5 (C mount)
(mm)

(Rear View)

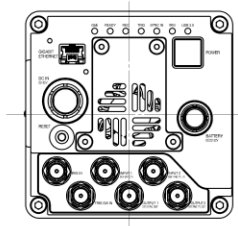

(Top View)

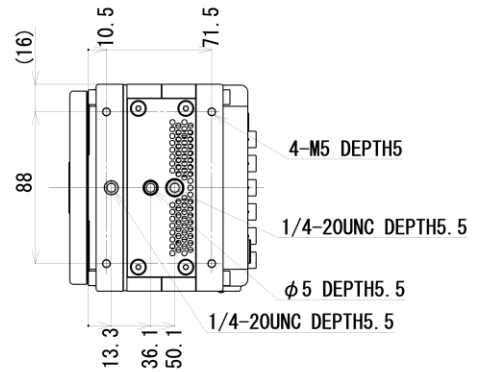

(Front View)

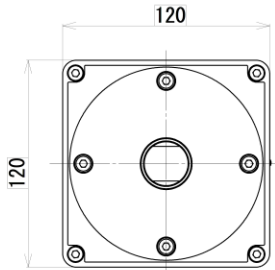

(Left Side View)

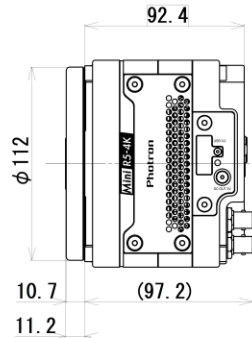

(Right Side View)

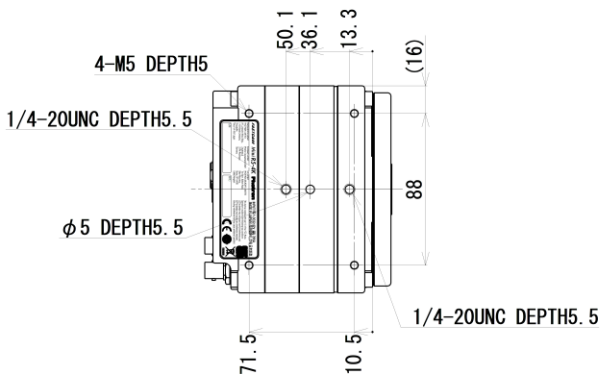

(Bottom View)

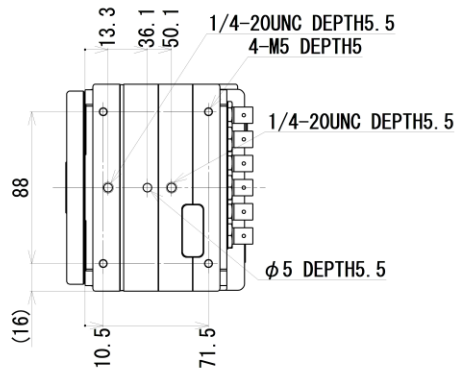

*** Caution**

If a screw that is longer than the specified length is forced into the hole, the screw hole and/or the camera may be damaged.

◆ FASTCAM Mini R3 / R5 (EF mount)
(mm)

(Rear View)

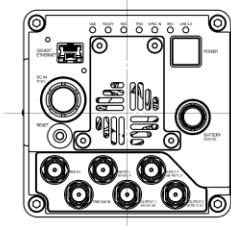

(Front View)

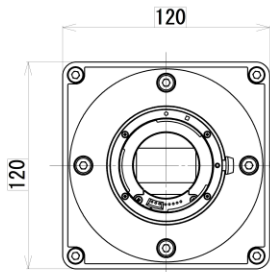

(Right Side View)

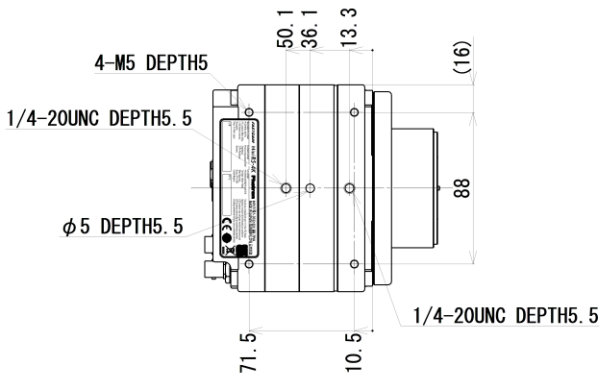

(Top View)

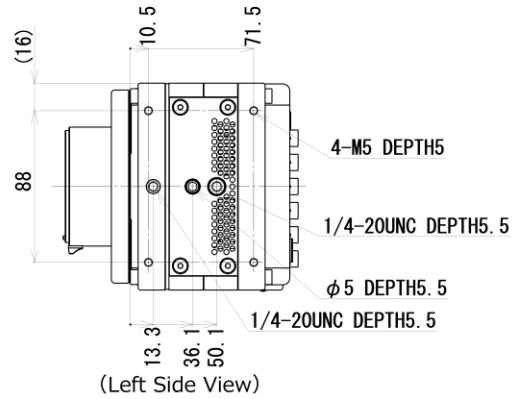

(Left Side View)

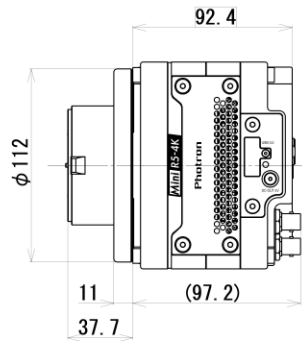

(Bottom View)

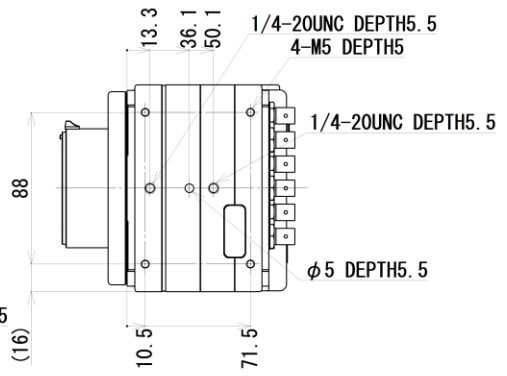

* Caution

If a screw that is longer than the specified length is forced into the hole, the screw hole and/or the camera may be damaged.

◆ FASTCAM Mini R3 / R5 (M42 mount)
(mm)

(Rear View)

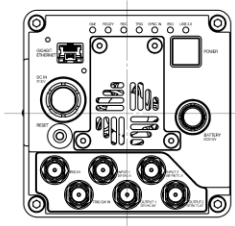

(Front View)

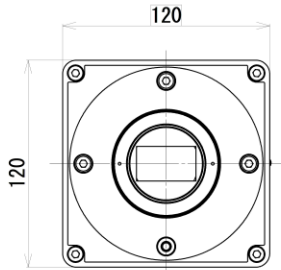

(Right Side View)

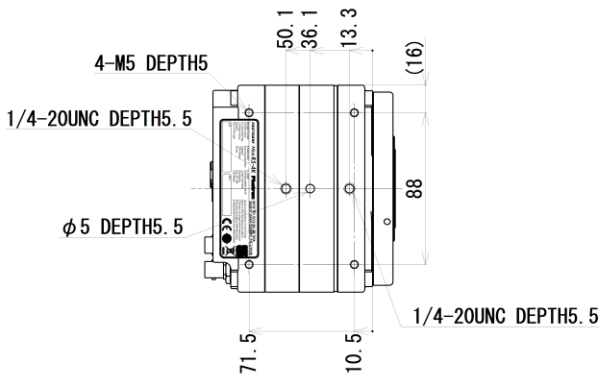

(Top View)

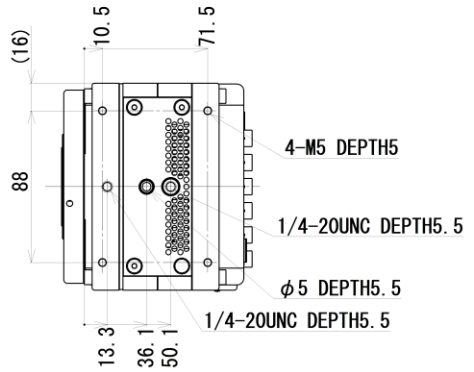

(Left Side View)

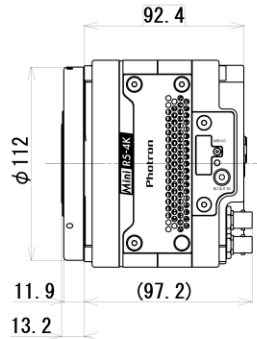

(Bottom View)

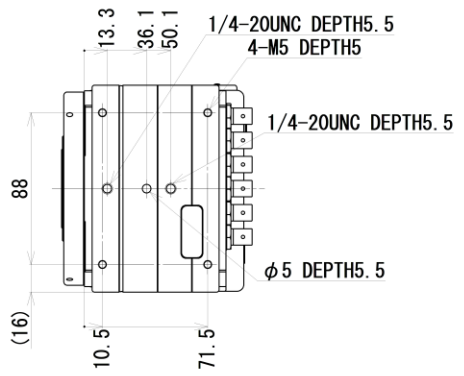

* Caution

If a screw that is longer than the specified length is forced into the hole, the screw hole and/or the camera may be damaged.

- ◆ R3 / R5 Sensor position (G type F mount)
(mm)

(Side Sectional Drawing)

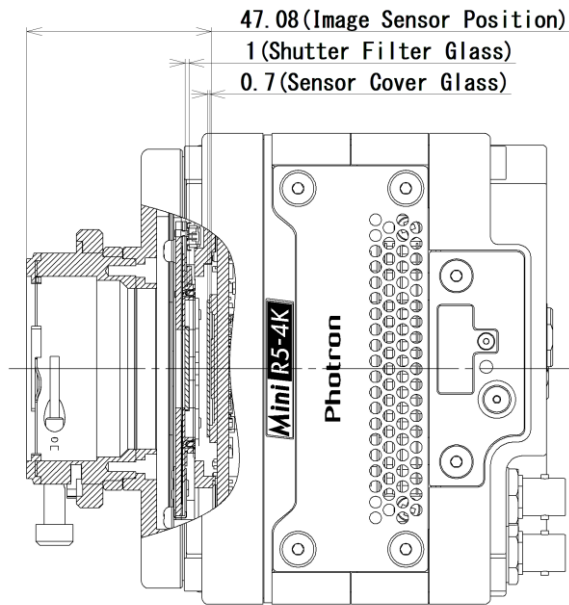

- ◆ R3 / R5 Sensor position (C mount)
(mm)

(Side Sectional Drawing)

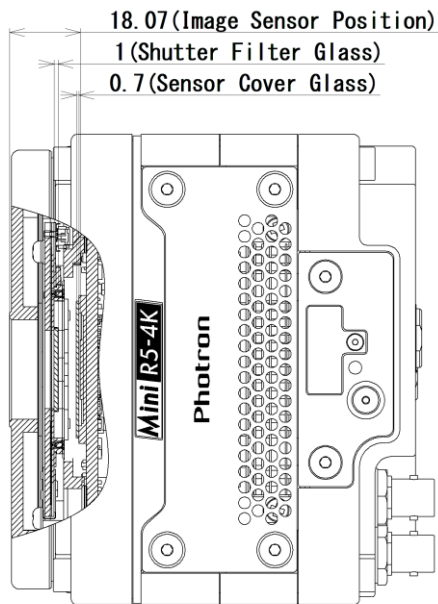

- ◆ R3 / R5 Sensor position (EF mount)
(mm)

(Side Sectional Drawing)

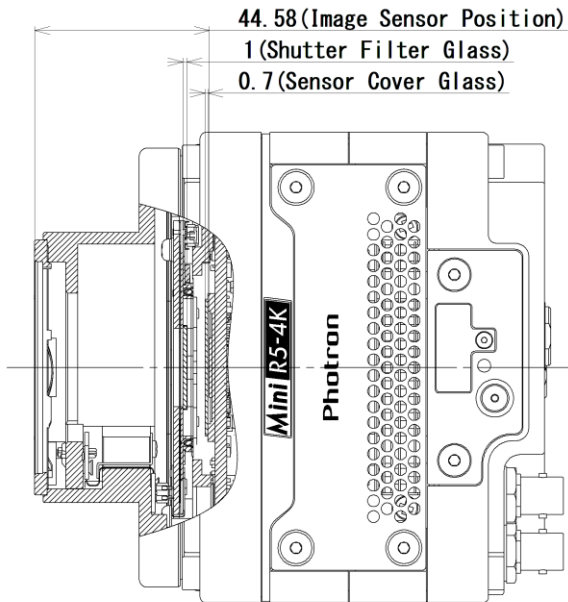

- ◆ R3 / R5 Sensor position (M42 mount)
(mm)

(Side Sectional Drawing)

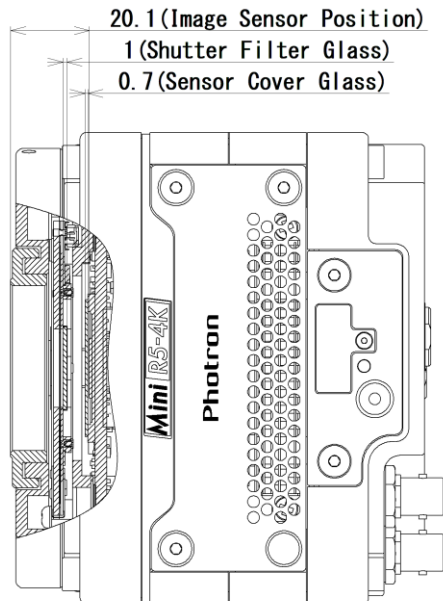

3.2.2 AC Adapter

(mm)

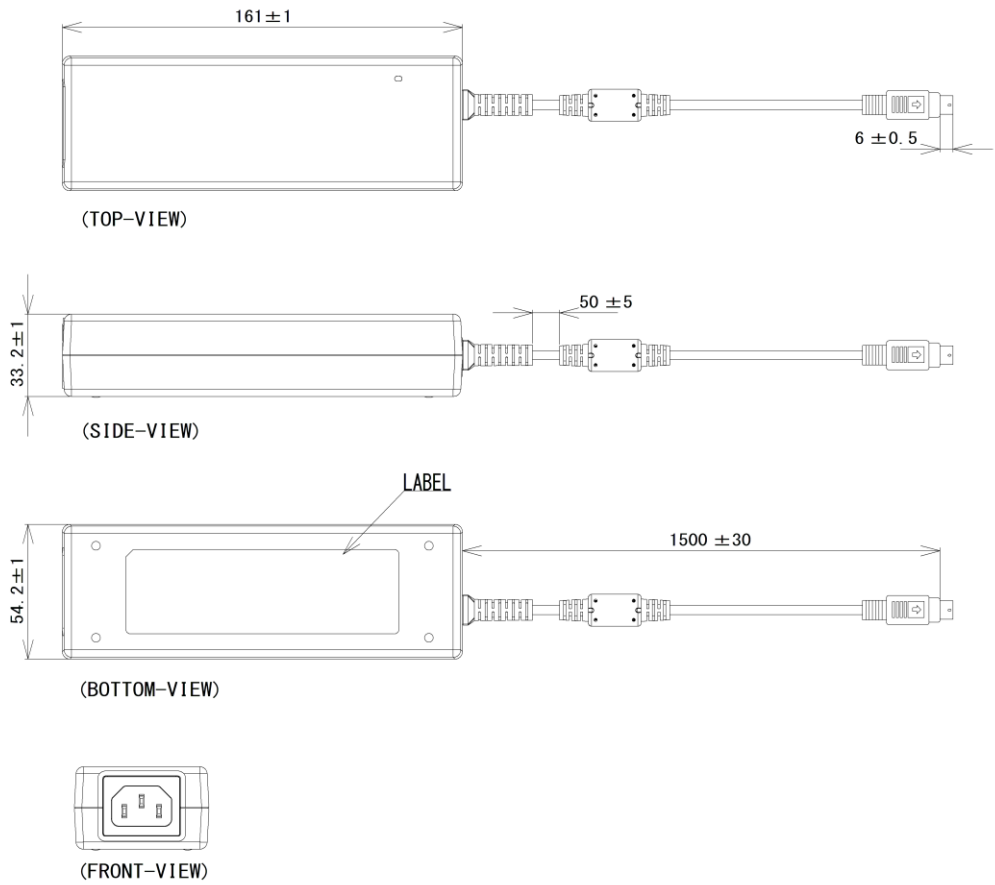

4

Chapter 4 Warranty

This chapter explains about the warranty.

4.1 About the Warranty

This system has been shipped having undergone rigorous testing. However, in the unlikely event that it malfunctions due to a manufacturing defect, it will be repaired, at no charge, within the warranty period.

◆ Warranty Exceptions

The following exceptions will result in fee-based repair, even within the warranty period.

1. Damage or malfunction as a result of fire, earthquake, water damage, lightning, other natural disasters, pollution, or the effects of abnormal voltage.
2. Damage or malfunction as a result of dropping or mishandling during shipment or when moving after purchase or misuse.
3. Consumable goods (cables)
4. When repair, adjustment, or alternation done by an entity other than Photron service has been performed on the system, or damage or malfunction that is determined to be attributed to a fault in the use the product.

For inquires related to malfunction, contact the dealer where the product was purchased, or the nearest Photron office.



REFERENCE

For inquires related to our product, refer to “5.1 Contact Information” on page 75.

5

Chapter 5 Contacting Photron

This chapter lists the contact information to use when contacting Photron if the system malfunctions or if a portion of the manual is unclear.

5.1 Contact Information

For inquiries related to FASTCAM Mini R series, contact Photron at one of the contact points listed below.

Additionally, the following items will be required for verification when inquiring. You are kindly asked to prepare them in advance.

Items Verified	Required Information
Contact Information	Company, school or organization name, customer contact name, contact phone number, contact e-mail address.
Product Name	FASTCAM Mini R3-4K / FASTCAM Mini R5-4K
Serial Number	Shown in the nameplate seal.
Condition of the system, nature of problem, etc.	

Contact Information	
In Americas and Antipodes	PHOTRON USA, INC. 9520 Padgett Street, Suite 110, San Diego, CA 92126-4426, USA Phone: +1 (800) 585 2129 or +1 (858) 684 3555 Fax: +1 (858) 684 3558 E-mail: image@photron.com Web: www.photron.com
In UK, Africa and India	PHOTRON (EUROPE) LIMITED The Barn, Bottom Road, West Wycombe, Buckinghamshire HP14 4BS, U.K. Phone: +44 (0) 1494 48 1011 Fax: +44 (0) 1494 48 7011 E-mail: image@photron.com Web: www.photron.com
In Europe outside the UK	Photron Deutschland GmbH Ziegelweg 3, 72764 Reutlingen, Germany Phone: +49 (0) 7121 699 7950 Fax: +49 (0) 7121 699 7943 E-mail: image@photron.com Web: www.photron.com
In China	PHOTRON (SHANGHAI) LIMITED Room 1601, No. 1, Lane 600, Tianshan Road, Changning District, Shanghai (TONGDA PROPERTY BUILDING) 200051 China Phone: +86 (21) 5268 3700 Fax: +86 (21) 5268 3702 E-mail: info@photron.cn.com Web: www.photron.cn.com
In other areas	PHOTRON LIMITED 21F, Jinbocho Mitsui Bldg., 1-105 Kanda Jimbocho, Chiyoda-Ku, Tokyo 101-0051, Japan Phone: +81 (3) 3518 6271 Fax: +81 (3) 3518 6279 E-mail: image@photron.co.jp Web: www.photron.co.jp

A

A. Appendix

A.1. Reference Information



CAUTION

The spectrum response curve and the quantum efficiency curve are nominal (reference) data of the image sensor device.

A.1.1 Relative Spectral Response (R3 / R5, monochrome, type-A)

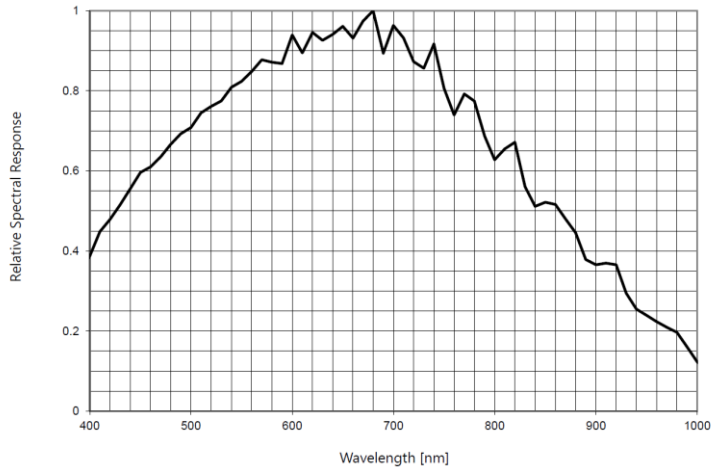

A.1.2 Quantum Efficiency (R3 / R5, monochrome, type-A)

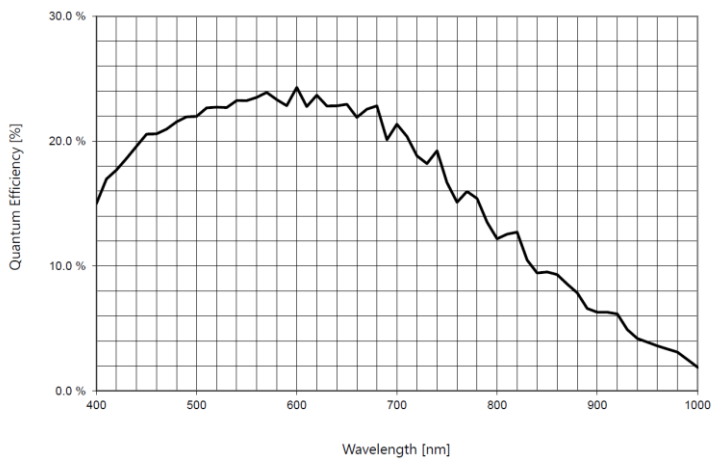

A.1.3 Relative Spectral Response (R3 / R5, color, type-A)



CAUTION

In the case of the color model, the IR cut filter is attached to the mechanical shutter, and the spectrum response curve and the quantum efficiency curve include it.

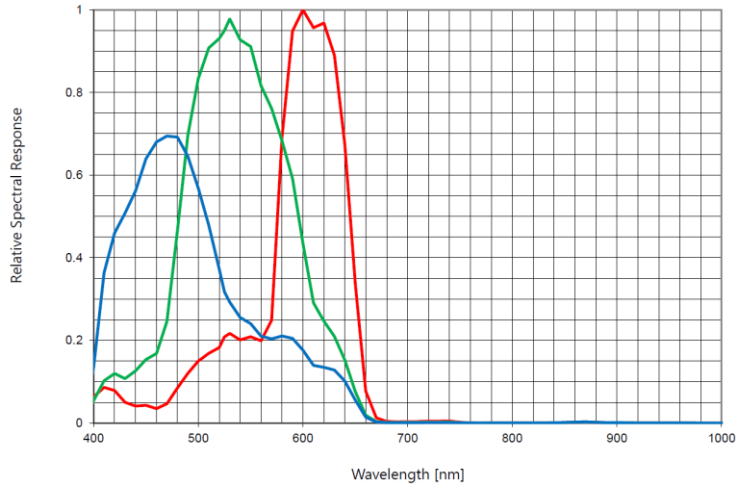

A.1.4 Quantum Efficiency (R3 / R5, color, type-A)



CAUTION

In the case of the color model, the IR cut filter is attached to the mechanical shutter, and the spectrum response curve and the quantum efficiency curve include it.

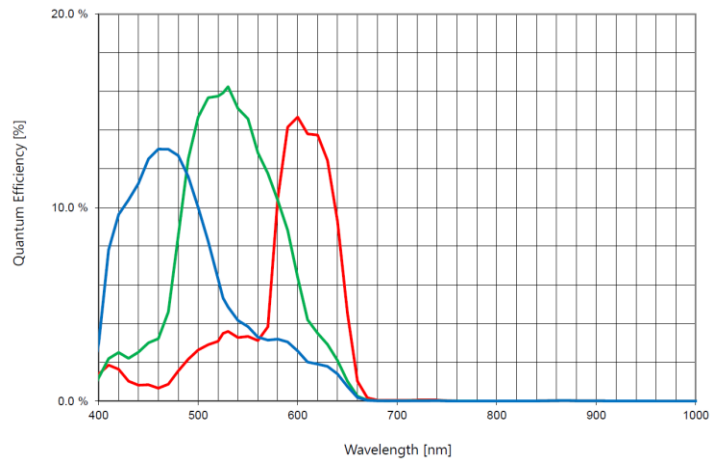

FASTCAM Mini R Series

Hardware Manual Rev. 4.04 E

Last Updated February 2025
Written by PHOTRON LIMITED
21F, Jinbocho Mitsui Bldg.,
1-105 Kanda Jimbocho, Chiyoda-Ku,
Tokyo 101-0051, Japan