

FASTCAM Mini UX

Hardware Manual

Rev. 4.10 E

Photron

WARNING

This equipment has been tested and found to comply with the limits for a Class A digital device, pursuant to part 15 of the FCC Rules. These limits are designed to provide reasonable protection against harmful interference when the equipment is operated in a commercial environment. This equipment generates, uses, and can radiate radio frequency energy and, if not installed and used in accordance with the instruction manual, may cause harmful interference to radio communications. Operation of this equipment in a residential area is likely to cause harmful interference in which case the user will be required to correct the interference at his own expense.

CAUTION:

Any changes or modifications not expressly approved by the party responsible for compliance could void the user's authority to operate the equipment.

The copyright of this manual is held by PHOTRON LIMITED.

Product specifications and manual contents are subject to change without notice.

PHOTRON LIMITED bears no responsibility for any results by using our products nor by applying this manual to any operations.

Introduction

Thank you for your purchase of Photron's high-speed camera system, the "FASTCAM Mini UX" (referred to below as the system).

This manual contains the operating instructions and warnings necessary for using the system. Before using the system, please read the entire manual.

If any part of this manual is unclear, contact Photron using the contact information printed at the back of the manual.

After you finish reading the manual, store it in a safe place along with the warranty card and refer back to it when necessary.

Using the Manual

This section explains the layout of the manual.

- Introduction

The introduction explains the manual and safety precautions.

- Chapter 1, Setup

This chapter gives an overview of the components that make up the system.

- Chapter 2, Recording

This chapter explains operations related to recording.

- Chapter 3, Product Specifications

This chapter explains the system's specifications.

- Chapter 4, Warranty





This chapter explains about the warranty.

- Chapter 5, Contacting Photron

This chapter lists the contact information to use when contacting Photron if the system malfunctions or if a portion of the manual is unclear.

Manual Notation

The following icons and symbols are used in the explanations in this manual.

Icon/Symbol	Description
 IMPORTANT	This symbol indicates content that should always be read.
 CAUTION	This symbol indicates instructions that should always be followed when using the software, or things to be careful of when using the software.
 NOTE	This symbol indicates supplementary items to be aware of when using the system.
 REFERENCE	This symbol indicates the location of a reference.
“ ”	This symbol is used to indicate the names of items on a screen, references, dialog names, and connectors.
[]	This symbol is used to indicate menu names, and sub-menu names.

Using the System Safely and Correctly

In order to prevent injury to yourself and others, and to prevent damage to property, carefully observe the following safety precautions.

Photron has given its full attention to the safety of this system. However, the extent of damage and injury potentially caused by ignoring the content of the safety precautions and using the system incorrectly is explained next. Please pay careful attention to the content of the safety precautions when using the system.



Warning

This symbol indicates actions that carry the risk that a person could receive a serious injury.



Caution

This symbol indicates actions that carry the risk that a person could receive a moderate injury, or that damage to physical property might occur.

- The safety precautions to be observed are explained with the following symbols.



This symbol indicates actions that require caution.



This symbol indicates actions that are prohibited and must be avoided.



This symbol indicates actions that must always be performed.



Warning



- Do not perform actions that will damage the AC cable or plug.
(Do not damage the cable, modify it, use it near a heater, excessively bend, twist or pull on it, place heavy objects on it, or bundle it.)
Using the cable when damaged can cause fire, electric shock, or a short circuit.



- Do not use the system in a manner which will exceed the rating of the power outlet or wiring equipment used.
Exceeding the power rating might cause a fire from excessive heat.



- Do not insert metallic objects inside, or pour liquids such as water on, the system.
Doing so can cause fire, electric shock, or malfunction from short circuit or heat.



- Do not disassemble or modify the system.
There are high voltages inside the system that can cause electric shock.



- Do not plug in or unplug the power cord with wet hands.
Doing so can cause electric shock.



- Make sure the power plug is fully insert into the socket.
Not fully plugging in the power cable can cause fire from electric shock or heat.



- When something is wrong with the system, unplug the power cable immediately.
 - When a foreign substance or liquid, such as metal or water, gets inside.
 - When the outer case is broken or damaged, such as from a fall.
 - When the system emits smoke, a strange smell, or strange sound.Using the system in these conditions might cause a fire or electric shock.



- Do not use the accessories by the usage that a manufacturer does not specify.
It may cause damage of protection.



Caution



- Always unplug the system when cleaning it or when it is unused for a long period of time. Leaving or storing the system connected to the power source might cause fire from insulation deterioration or electrical discharge.



- Please consult us in advance when you perform an event by which laser light or direct rays fall on the image sensor surface.



- Do not set the system in a location where the temperature gets unusually hot. The trunk and inside of a car can get especially hot in summer. Doing so can cause the outer case and internal components to deteriorate or cause a fire.



- Do not place the system in a location prone to oily smoke or steam, or in a location with a lot of humidity or dust. Oil, moisture, and dust conduct electricity, which can cause a fire or electric shock.



- Use the system in an environment with an ambient temperature of 0 to 40 °C, humidity of 85 % RH or lower, maximum altitude of 2,000 m or lower, and no condensation. Use in a condition out of the above limits can cause malfunction.



- Do not store the equipment in a location where the temperature goes below -20 °C or higher than 60 °C. Be sure not to allow condensation to form inside the system.



- When shipping, remove the connecting cable and use the original packaging or a dedicated carrying case. Do not ship the equipment in an environment where the temperature goes below -20 °C or higher than 60 °C. Also, prevent condensation from forming during shipment.



Handling of the AC Adapter

To ensure safe use of the Photron FASTCAM series, please follow the instructions for proper storage of the supplied AC adapter.

If there is any problem with the AC adapter or cable, stop using it immediately and contact your local Photron office.

■ Storage Method

- When storing the AC adapter or cable, make sure that no stress is placed on the root of the AC adapter or the cable.
- Do not wrap the cable around the AC adapter, but loosely bundle it.
- When storing the AC adapter in the camera's carrying case, store it so that no strain is placed on the root of the AC adapter and the cable.



Bad example

Cable is wound too tightly.



Strain on the root.



Good example

No strain on the root.



Cable is loosely bundled.

■ Appearance Check

- Before use, check the appearance of the AC adapter and cable for any abnormalities.
- If there are any cracks or tears on the surface, it may cause fire, electric shock, or short circuit.

Immediately stop using the AC adapter and contact your local Photron office.





European Union (and EEA) only



“CE” mark indicates that this product complies with the European requirements for safety, health, environment, and customer protection. “CE” mark equipments are intended for sales in Europe.



These symbols indicate that this product is not to be disposed of with your household waste, according to the WEEE Directive (2002/96/EC), the Battery Directive (2006/66/EC) and/or your national laws implementing those Directives.



This product should be handed over to a designated collection point, e.g., on an authorized one-for-one basis when you buy a new similar product or to an authorized collection site for recycling waste electrical and electronic equipment (EEE) and batteries and accumulators. Improper handling of this type of waste could have a possible impact on the environment and human health due to potentially hazardous substances that are generally associated with EEE. Your cooperation in the correct disposal of this product will contribute to the effective usage of natural resources.

For more information about the recycling of this product, please contact your local city office, waste authority, approved scheme or your household waste disposal service or visit www.photron.com.

(EEA: Norway, Iceland, and Liechtenstein)



This product is in conformity with the protection requirements of EU Council Directive 2014/30/EU (Class A) on the approximation of the laws of the Member States relating to electromagnetic compatibility.

Warning: This is a Class A product. In a domestic environment, this product may cause radio interference, in which case the user may be required to take adequate measures.



Cleaning of the Image Sensor Surface

Electrostatic Discharge (ESD) events may cause immediate and unrecoverable damage to the image sensor.

Read the following instructions and take EXTREME CARE when cleaning the image sensor surface.



- ALWAYS take appropriate anti-static precautions when cleaning or working near the Image sensor.
- DO NOT use any form of cleaning equipment using electrostatic or 'charged fiber' technology.



- Discharge any electrostatic build up in your body by touching a grounded metallic surface before working near the camera sensor.
- Very gently, use only clean and dry air to remove dust from surface of the image sensor.
- To remove stubborn contamination, use the highest grade (e.g. VLSI grade) pure Isopropyl alcohol (IPA) with optical wipes of 'clean room' grade.
- Extreme care must be taken! Gently wipe across the sensor in a single action.
DO NOT rub to avoid abrasive damage to delicate optical coatings on the glass surface.

Contents

Chapter 1 Setup	14
1.1 About the System's Components and Accessories.....	15
1.1.1 Components.....	15
1.1.2 Options.....	15
1.1.3 Type.....	16
1.2 Part Names.....	17
1.2.1 Camera Body.....	17
1.2.2 Camera Body Part Names.....	18
1.2.3 Interchangeable Lens Mounts.....	19
1.2.4 Status Display LEDs on the Rear of the Camera Body.....	20
1.2.5 Camera IP Address Initialization.....	21
1.2.6 Reset to the Factory Default.....	22
1.2.7 Power Supply Connector, DC Cable.....	23
1.2.8 Connecting the Gigabit Ethernet Interface to a PC.....	25
1.3 Input/Output Signal Types.....	26
1.3.1 TRIG TTL IN Connector.....	26
1.3.2 IRIG IN Connector.....	26
1.3.3 INPUT (1, 2) Connector.....	27
1.3.4 OUTPUT (1, 2) Connector.....	28
1.3.5 Inputting an External Synchronization Signal.....	29
1.3.6 Outputting an External Synchronization Signal.....	29
1.3.7 Synchronization with a Variable Frequency.....	30
1.3.8 INPUT, TRIG SW IN Circuit Diagram.....	31
1.3.9 IRIG-sync Operation.....	32
1.3.10 Setting of Input/Output Signals and Sync Output Rate.....	33
1.4 Device Connections.....	35
1.4.1 Minimum Equipment Connection.....	35
1.4.2 Connecting the AC Adapter.....	36
1.4.3 Connecting a PC.....	37
Chapter 2 Recording	38
2.1 Selecting Frame Rate / Resolution.....	39
2.1.1 Low Shutter Speed Mode.....	39
2.2 Selecting Shutter Speed.....	40
Chapter 3 Product Specifications	41
3.1 Specifications.....	42
3.1.1 Product Specifications.....	42
3.1.2 Other Supported Function.....	42
3.1.3 General Specifications.....	43

3.1.4	AC Adapter	43
3.1.5	Frame Rate and Resolution	44
3.1.6	Shutter Speed List.....	49
3.1.7	Recordable Frames / Resolution	51
3.1.8	Recordable Time / Resolution.....	53
3.1.9	Timing Diagram	55
3.1.10	Inter Frame Time.....	59
3.2	Dimensions	60
3.2.1	Camera Body.....	60
3.2.2	Sensor Position	62
3.2.3	AC Adapter	63
Chapter 4 Warranty		64
4.1	About the Warranty.....	65
Chapter 5 Contacting Photron		66
5.1	Contact Information	67
A. Appendix		68
A.1.	Reference Information	69
A.1.1	Mini UX50 Relative Spectral Response (monochrome)	69
A.1.2	Mini UX50 Quantum Efficiency (monochrome)	69
A.1.3	Mini UX100 Relative Spectral Response (monochrome).....	70
A.1.4	Mini UX100 Quantum Efficiency (monochrome).....	70
A.1.5	Mini UX50 Relative Spectral Response (color).....	71
A.1.6	Mini UX50 Quantum Efficiency (color)	71
A.1.7	Mini UX100 Relative Spectral Response (color)	72
A.1.8	Mini UX100 Quantum Efficiency (color).....	72

1

Chapter 1 Setup

This chapter gives an overview of the components that make up the system.

1.1 About the System's Components and Accessories

1.1.1 Components

Refer to the attached packing list for this product's standard components and accessories.



NOTE

This system does not include a lens.

1.1.2 Options

The following options are available for the system.

1. Dedicated Carrying Case
2. C Mount Adapter
3. Photron Master Camera Hub, Photron Camera Hub



NOTE

Lenses, lighting equipments and other kinds of options are available.

Please contact our sales representative or distributors. Please refer to "5.1 Contact Information".



Use only the components and accessories/options specified on the "1.1 About the System's Components and Accessories" for AC adapter / AC cable and others.

1.1.3 Type

For the FASTCAM Mini UX50/100 system, there are monochrome and color versions, and for each of these versions, there are standard memory type of 4GB and high-capacity memory types of 8GB, 16GB, and 32GB. When purchasing, it is possible to select from these models according to the application or your demands. The type categories are listed as follows.

Max. Frame Rate	Full Frame Max.	Sensor Type	Memory	Type Name
800,000fps	4,000fps	Color	4GB	FASTCAM Mini UX100 type 800KC – 4GB
			8GB	FASTCAM Mini UX100 type 800KC – 8GB
			16GB	FASTCAM Mini UX100 type 800KC – 16GB
			32GB	FASTCAM Mini UX100 type 800KC – 32GB
		Mono	4GB	FASTCAM Mini UX100 type 800KM – 4GB
			8GB	FASTCAM Mini UX100 type 800KM – 8GB
			16GB	FASTCAM Mini UX100 type 800KM – 16GB
			32GB	FASTCAM Mini UX100 type 800KM – 32GB
204,800fps	4,000fps	Color	4GB	FASTCAM Mini UX100 type 200KC – 4GB
			8GB	FASTCAM Mini UX100 type 200KC – 8GB
			16GB	FASTCAM Mini UX100 type 200KC – 16GB
			32GB	FASTCAM Mini UX100 type 200KC – 32GB
		Mono	4GB	FASTCAM Mini UX100 type 200KM – 4GB
			8GB	FASTCAM Mini UX100 type 200KM – 8GB
			16GB	FASTCAM Mini UX100 type 200KM – 16GB
			32GB	FASTCAM Mini UX100 type 200KM – 32GB
160,000fps	2,000fps	Color	4GB	FASTCAM Mini UX50 type 160KC – 4GB
			8GB	FASTCAM Mini UX50 type 160KC – 8GB
			16GB	FASTCAM Mini UX50 type 160KC – 16GB
			32GB	FASTCAM Mini UX50 type 160KC – 32GB
		Mono	4GB	FASTCAM Mini UX50 type 160KM – 4GB
			8GB	FASTCAM Mini UX50 type 160KM – 8GB
			16GB	FASTCAM Mini UX50 type 160KM – 16GB
			32GB	FASTCAM Mini UX50 type 160KM – 32GB



CAUTION

Export control model: Frame rate and shutter speed are limited at the type 200K.



REFERENCE

Subject to restrictions under Export Trade Control Order, your camera may NOT be used depending on the country where you intend to use. If you are considering exporting your camera, check with Photron first.

Contact information is given in “Chapter 5 Contacting Photron”, page 67.

1.2 Part Names

The system is composed of components including the camera body, AC adapter, and the “Photron FASTCAM Viewer” control software (referred to below as PFV).



For the camera body and the AC adapter

- Do not expose the camera body, AC adapter and other optional components to shock.
- Do not use in an area where flammable gas or dust is present.
- Do not place in an unstable location such as on an unstable platform or an incline.
- Do not disassemble or modify.
- Do not expose to liquids such as water.
- Do not subject to an excessive force.

1.2.1 Camera Body

The camera body contains IC memory for image recording and has been designed to be able to record high-speed images uncompressed. The back of the camera body is equipped with the video output terminals, which can playback the recorded images on a video monitor; the Gigabit Ethernet interface, which permits full camera control and data download possible via connection to a PC; the input/output connector, which allows external synchronization signals, trigger signals, IRIG time code.

1.2.2 Camera Body Part Names

◆ FASTCAM Mini UX50/100

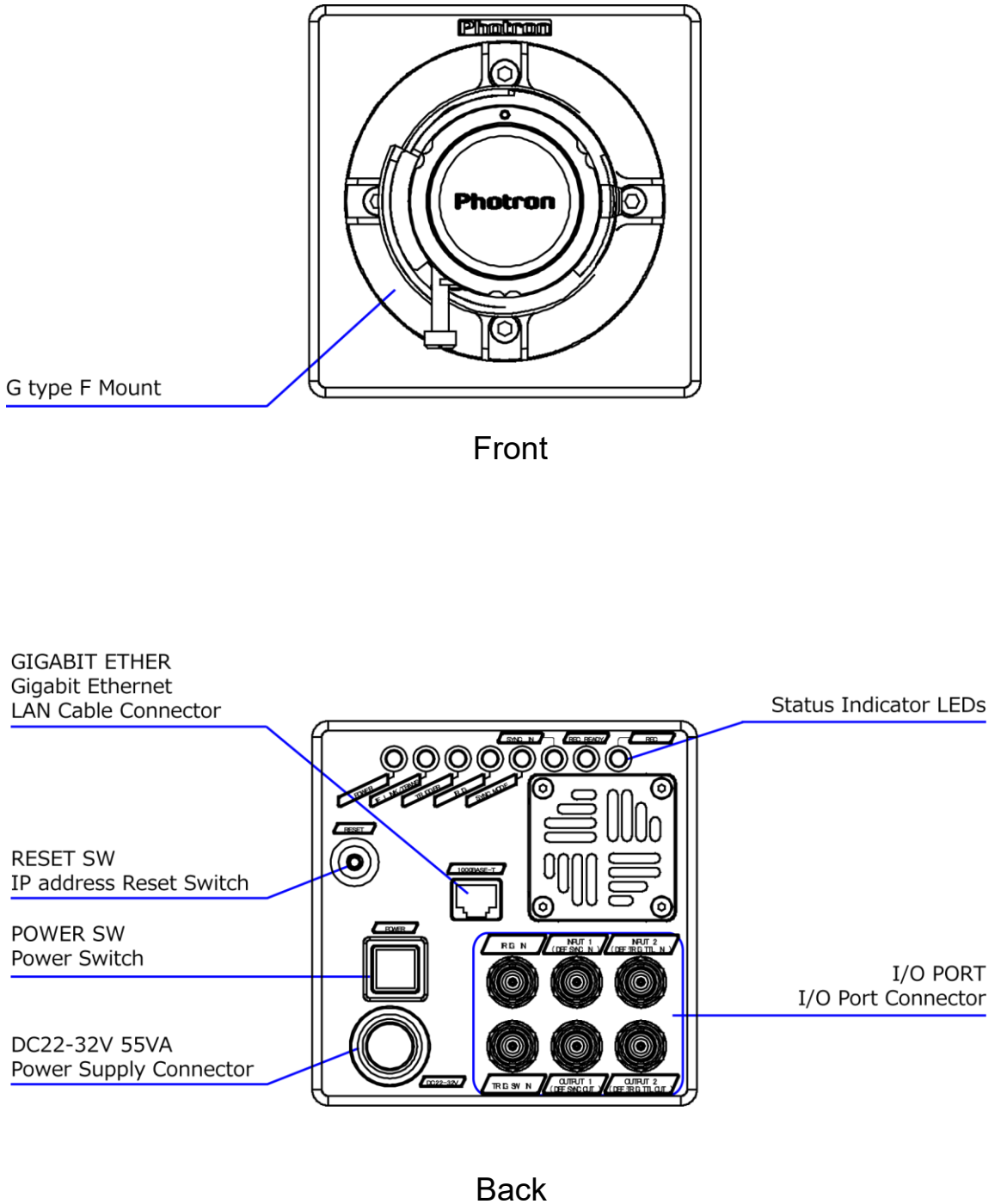

1.2.3 Interchangeable Lens Mounts

The lens mount on the system can be changed according to the recording purpose.

There are two types of interchangeable lens mounts, including option: “G type F mount”, “C mount”.

◆ How to change the lens mount (G type F Mount → C Mount)

1. Remove the four M5 bolts with the hexagonal holes using the hexagonal wrench.
2. Remove the G type F Mount portion as a unit.
3. Install the C Mount unit using the bolts with hexagonal holes in the 90° diagonal holes.
4. After installation, always verify that the unit is not loose and does not rattle.

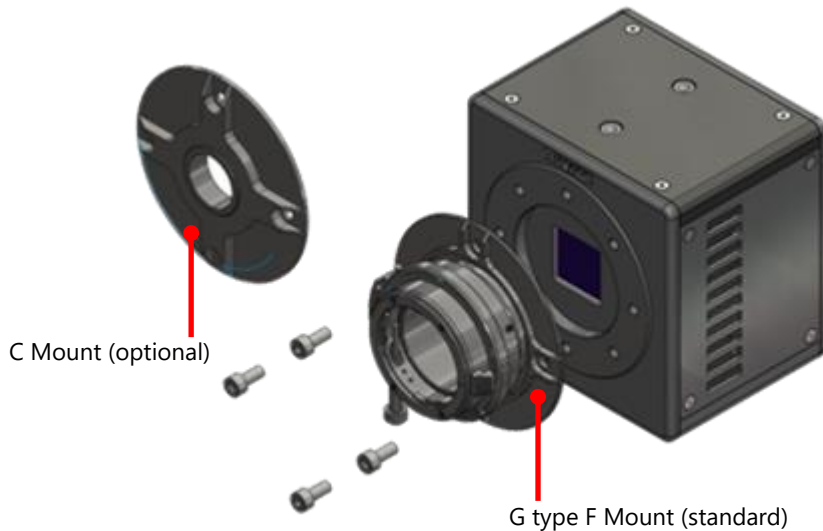

⚠ CAUTION









- When using a C-mount, the following restrictions apply to the lens to be used.
Protrusion from the lens mount flange to the image sensor (a) 14 mm maximum



1.2.4 Status Display LEDs on the Rear of the Camera Body

There are a number of LEDs on the rear of the system's camera body. These LEDs indicate the status of the system. The function of each LED is explained here.



Item	Color	ON	FLASHING	OFF
POWER		Power On	—	Power Off
IF LINK /TRANS		The Gigabit Ethernet interface is connected	Data is transferring	The Gigabit Ethernet interface is not connected
TRIGGER		A trigger signal is present (being input) (The LED will illuminate for 0.1 second when the trigger signal is input.)	—	The trigger signal is not present
IRIG		The IRIG signal is present (being input)	—	The IRIG signal is not present
SYNC MODE		In external synchronization mode (synchronized to an external signal)	—	In internal synchronization mode (synchronized to the internal signal)
SYNC IN		A synchronization signal is present (being input)	—	A synchronization signal is not present
REC READY		ON: Ready to record	ENDLESS recording (The REC (Red) LED is also flashing)	Not ready to record
REC		Ready to record (The case of "ENDLESS" recording mode)	Recording	Not recording

◆ Illumination/blinking in operational states

- During the Gigabit Ethernet interface initialization LEDs other than POWER (green) and IF LINK/TRANS (red) blink alternately from right to left and from left to right a number of times. When Factory Default is executed, LEDs other than POWER (green) and IF LINK/TRANS (red) fade out from right to left a number of times, then blink.



REFERENCE

For how to initialize the Gigabit Ethernet interface, and how to reset to Factory Default, refer to "1.2.5 Camera IP Address Initialization" on page 21 and "1.2.6 Reset to the Factory Default" on page 22.

1.2.5 Camera IP Address Initialization

In some circumstance when the IP address is changed, and the new IP address is not explicit, an IP Address Initialization operation is recommended. In this case, the IP address will be reset to 192.168.0.10 as the factory settings.

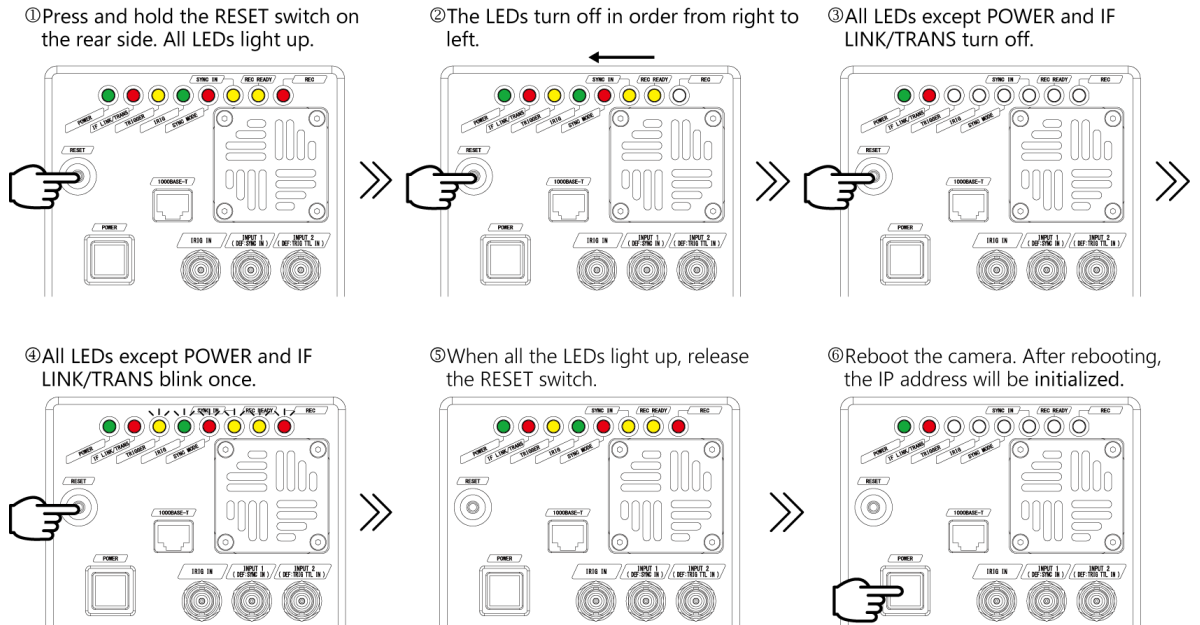

CAUTION

- If the RESET switch is released while the LEDs light up and turn off repeatedly from right to left, the IP address initialization will not be completed. Be sure to keep pressing the switch until all LEDs blink and then light up.
- If you continue to hold down the RESET switch after IP address initialization, “Reset to the Factory Default” will be executed.

1.2.6 Reset to the Factory Default

Camera settings can be reset to the factory default state by the following procedure.

① Press and hold the RESET switch on the rear side. All LEDs light up.

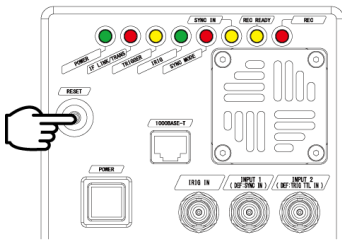

② The LEDs turn off in order from right to left.

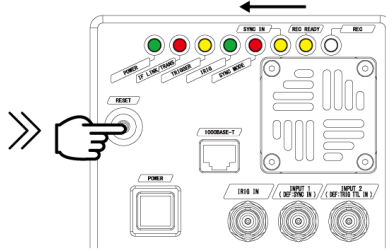

③ All LEDs except POWER and IF LINK/TRANS turn off.

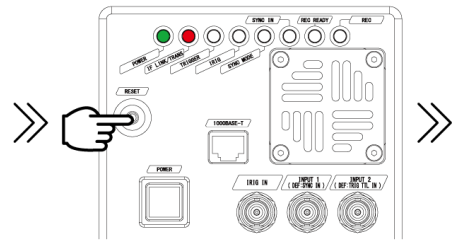

④ All LEDs except POWER and IF LINK/TRANS blink once.

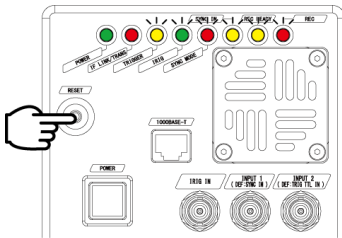

⑤ When all the LEDs light up, release the RESET switch.

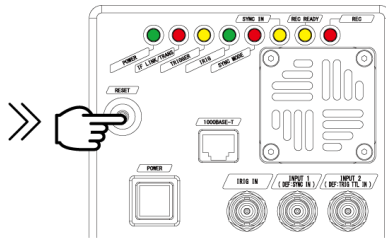

• • • × 3 times

⑥ All LEDs except POWER and IF LINK/TRANS keep blinking.

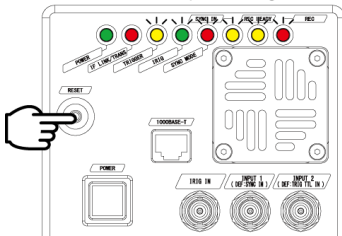

⑦ Release the RESET switch.

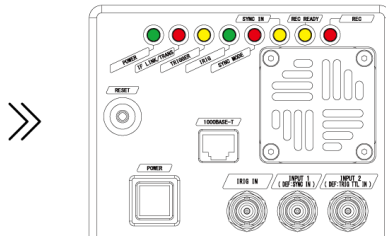

⑧ Reboot the camera. After rebooting, The camera is initialized to factory default.

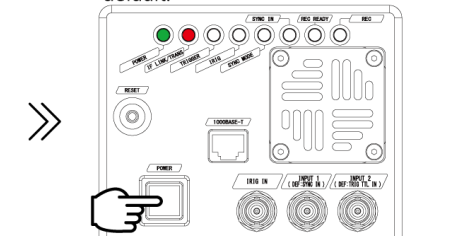

CAUTION

- When the LEDs light up and turn off repeatedly from bottom to top for three times and the LEDs keep blinking, the system is reset to factory default.
- If you release the RESET switch before the LEDs keep blinking, only the IP address initialization is performed.
- When the factory default is performed from PFV, all the LEDs keep lighting up, when the initialization is accomplished.

1.2.7 Power Supply Connector, DC Cable

The DC power supply input connector. Connect to the supplied AC adapter or the optional High-G Battery.

The cable connector is optionally available. When using other power supplies, construct a cable using the pin diagram below as a reference.

DC22-32V 55VA (on camera body) Pin layout	Cable connector (to camera body) Pin layout
ECJ.2B.326.CLD(LEMO)	FGJ.2B.326.CLLD52Z(LEMO)

Connector Name	Signal Name	Pin No.	Camera Body Connector Model Name (Manufacturer)	Cable Connector Model Name (Manufacturer)
DC22-32	READY OUT	1	ECJ.2B.326.CLD (LEMO)	FGJ.2B.326.CLLD52Z (LEMO)
	GND	2		
	RESERVE	3		
	RESERVE	4		
	RESERVE	5		
	RESERVE	6		
	RESERVE	7		
	RESERVE	8		
	IRIG GND	9		
	IRIG	10		
	SYNC IN *1	11		
	TTL IN *2	12		
	OUTPUT2 *3	13		
	OUTPUT1 *4	14		
	GND	15		
	GND	16		
	RESERVE	17		
	RESERVE	18		
	GND	19		
	NC	20		
	READY IN	21		
	NC	22		
	+22 - +32V (Input)	23		
	+22 - +32V (Input)	24		
	+22 - +32V (Input)	25		
	NC	26		

- *1 Cannot be used together with INPUT1
- *2 Cannot be used together with INPUT2
- *3 Cannot be used together with OUTPUT2
- *4 Cannot be used together with OUTPUT1



Warning

When using the connector pins directly, refer to the chart above and ensure the wiring is correct. If the wiring is incorrect, not only is there the danger of the system malfunctioning, but also of fire and electric shock.



Warning

Do not use a power supply which does not meet the system's specifications, or a power supply you cannot guarantee the safety of.

By using a power supply outside of the system specifications, not only is there the danger of the system malfunctioning, but also of fire and electric shock.



Warning

Please use an external power supply with the suitable rating which was estimated by IEC61010-1:2010, AMD1:2016, and separated from the main circuit by double insulation or reinforced insulation.

1.2.8 Connecting the Gigabit Ethernet Interface to a PC

The system can have the operation of its functions performed from a PC using the Gigabit Ethernet interface. This section explains the required setup when connecting the system to a PC.

To connect a PC to the system, connect the system to a commercially available 1000BASE-T-compatible interface board with a LAN cable. If High-G is not required, a commercial LAN cable can be used. For the LAN cable, prepare a UTP or STP Cat 5e (enhanced category 5) or higher LAN cable. (UTP: Unshielded Twisted Pair, STP: Shielded Twisted Pair)

The maximum cable length between the PC and the system is 100 m (compliant to the 1000BASE-T specification). One PC can connect to a maximum of 64 Photron Gigabit Ethernet interface equipped cameras using a hub. When connecting multiple devices, connect through a switching hub that can connect at 1000BASE-T. The maximum length of the cable that connects the system (or PC) to the switching hub is also 100 m.



NOTE

Photron recommends using an STP cable over long distances or in noisy locations.



IMPORTANT

The system's factory default IP address is below:

IP ADDRESS: 192.168.0.10

PORT: 2000 (UDP, Fixed, not changeable)

1.3 Input/Output Signal Types

With the system, many signals can be input and output through the I/O cable. Signals that can be input and output from the I/O cable are listed below.



A signal other than the specified signal must not be input to the various connectors.

Use extreme caution as there is a risk of damage to both, the input device and the output device.



REFERENCE

Refer to “10.6.1 Setting External I/O Port” of “Photron FASTCAM Viewer User’s Manual” for the details of the setup.

The followings are I/O connectors and related signals.

1.3.1 TRIG TTL IN Connector

This trigger is input during the READY or ENDLESS recording state by contact between the BNC connector’s shield and a center pin (switch closure). The center pin normally has voltage flowing through it. Use caution to avoiding contact with other pins.

Connector Name (Input System)	Menu	Signal
TRIG SW IN	None	Contact signal

1.3.2 IRIG IN Connector

The system supports IRIG-B input and can add an IRIG code to each recorded frame. The sample timing for the IRIG code is once each frame.

The recorded IRIG code is displayed with the PFV

◆ IRIG Code Input Specification

Connector	BNC
Code Format	IRIG-B (122) Analog
Amplitude	3.0Vp-p min,8.0Vp-p max
Mark to space ratio	3:1 to 6:1
Typical modulated carrier signal ratio	10:1



REFERENCE

Refer to “10.6 I/O Settings” of “Photron FASTCAM Viewer User’s Manual” for the details of the setup.



NOTE

- IRIG Time Code is used when synchronizing a camera with external equipment in time. It is a convenient function when apparatus is physically separated.
- When the IRIG code is being input, the IRIG code is displayed in white, and is displayed to the left.
- The IRIG offset time is also displayed below it. When the IRIG code is not being input, the IRIG code is displayed in grey. At that time, the counter is the camera’s internal counter and it continues to count.

1.3.3 INPUT (1, 2) Connector

The effect when a signal is input is described below and can be optionally selected and set.

The input voltage is 0V to +12V (H level +3.3V to +12V), positive or negative polarity, pulse width is 200 ns or greater.

Default settings are INPUT1 connector is assigned “SYNC POS”, INPUT2 connector is assigned “TRIG POS”.

Menu Display	Contents	Signal (Input Signal Conditions)
TRIG POS	Inputs a positive polarity trigger signal.	FET Input 0V - +12V (H level +3.3V to +12V), Positive Polarity
TRIG NEG	Inputs a negative polarity trigger signal.	FET Input 0V - +12V (H level +3.3V to +12V), Negative Polarity
READY POS	Inputs a positive polarity READY signal. READY ON/OFF is switched by a pulse input.	FET Input 0V - +12V (H level +3.3V to +12V), Positive Polarity
READY NEG	Inputs a negative polarity READY signal. READY ON/OFF is switched by a pulse input.	FET Input 0V - +12V (H level +3.3V to +12V), Negative Polarity
EVENT POS	Inputs a positive polarity EVENT signal. EVENT TRIGGER is recorded by a pulse input.	FET Input 0V - +12V (H level +3.3V to +12V), Positive Polarity
EVENT NEG	Inputs a negative polarity EVENT signal. EVENT TRIGGER is recorded by a pulse input.	FET Input 0V - +12V (H level +3.3V to +12V), Negative Polarity



NOTE

- When 2 or more these systems are synchronized, slave cameras’ external synchronization settings should be set “ON CAM” at PFV.
- The event marker can store ten positions within a sequence.

1.3.4 OUTPUT (1, 2) Connector

These are also BNC connectors. The signals below can be changed and output from PFV. The output voltage is 0V to +5V, positive or negative polarity, pulse width can be changed. Default settings are OUTPUT1 connector is “SYNC POS”, OUTPUT2 is “TRIG POS”.

(POS: positive polarity, NEG: negative)

Menu Display	Contents	Signal Type
SYNC POS	Outputs a positive polarity vertical synchronization signal.	+5V CMOS output, Positive Polarity
SYNC NEG	Outputs a negative polarity vertical synchronization signal.	+5V CMOS output, Negative Polarity
EXPOSE POS	Outputs the sensor's exposure interval at H level.	+5V CMOS output, Positive Polarity
EXPOSE NEG	Outputs the sensor's exposure interval at L level.	+5V CMOS output, Negative Polarity
REC POS	Outputs an interval signal during recording at H level.	+5V CMOS output, Positive Polarity
REC NEG	Outputs an interval signal during recording at L level.	+5V CMOS output Negative Polarity
TRIG POS	Outputs the trigger signal received by the camera at H level.	+5V CMOS output, Positive Polarity For TRIG SW IN, approx 20.4 μ sec. For INPUT, approx 220 nsec.
TRIG NEG	Outputs the trigger signal received by the camera at L level.	+5V CMOS output, Negative Polarity For TRIG SW IN, approx 20.4 μ sec. For INPUT, approx 228 nsec.
READY POS	Outputs a signal at H level during the trigger wait state. (READY in START mode.) Only valid during START, CENTER, END, and MANUAL modes.	+5V CMOS output, Positive Polarity
READY NEG	Outputs a signal at L level during the trigger wait state. (ENDLESS recording state in CENTER, END, MANUAL) Only valid during START, CENTER, END, and MANUAL modes.	+5V CMOS output, Negative Polarity
IRIG RESET POS	Outputs the camera's internal IRIG reset signal (1PPS) at H level.	+5 V CMOS output, Positive Polarity
IRIG RESET NEG	Outputs the camera's internal IRIG reset signal (1PPS) at L level.	+5 V CMOS output, Negative Polarity

When using 50 cm cable from the signal generator to the camera

1.3.5 Inputting an External Synchronization Signal

When INPUT 1 or 2 is set to SYNC POS/NEG, an external synchronization signal can be input with the system. See the chart below for external synchronization input settings.

Menu Display	Contents	Signal (Input Signal Conditions)
OFF	Sets external synchronization off, operates independently.	(none)
ON CAM POS	The camera synchronizes external positive signals lower than the currently set frequency. The frequency set at the beginning is displayed.	FET Input 0V - +12V (H level +3.3V to +12V), Positive Polarity
ON CAM NEG	The camera synchronizes external negative signals lower than the currently set frequency. The frequency set at the beginning is displayed.	FET Input 0V - +12V (H level +3.3V to +12V), Negative Polarity
ON OTHERS POS	The camera synchronizes the positive signal that was input when the setting is changed to ON OTHERS POS. The frequency at the time of setting change is displayed, and the system synchronizes signals lower than this frequency. After synchronization setting, shutter speed and resolution can be changed but frame rate can not be changed.	FET Input 0V - +12V (H level +3.3V to +12V), Positive Polarity
ON OTHERS NEG	The camera synchronizes the negative signal that was input when the setting is changed to ON OTHERS NEG. The frequency at the time of setting change is displayed, and the system synchronizes signals lower than this frequency. After synchronization setting, shutter speed and resolution can be changed but frame rate can not be changed.	FET Input 0V - +12V (H level +3.3V to +12V), Negative Polarity



CAUTION

The frequency which can input during ON OTHERS setting is limited to integer frequency. Inputting a signal for instance at 1000.5 Hz may cause dropped frames.

1.3.6 Outputting an External Synchronization Signal

The system can externally output a synchronization signal.

Menu Display	Contents	Signal Type	Delay Time
SYNC POS	Outputs a positive polarity vertical synchronization signal.	CMOS (74ACT541 buffer) output, positive polarity	Approx. 118 nsec
SYNC NEG	Outputs a negative polarity vertical synchronization signal.	CMOS (74ACT541 buffer) output, negative polarity	Approx. 138 nsec

1.3.7 Synchronization with a Variable Frequency

When synchronizing with a varying input frequency signal, the frame rate and resolution specified before recording will be kept as a maximum value.



NOTE

When an input sync signal is variable, the output image quality might be worse.

1.3.8 INPUT, TRIG SW IN Circuit Diagram

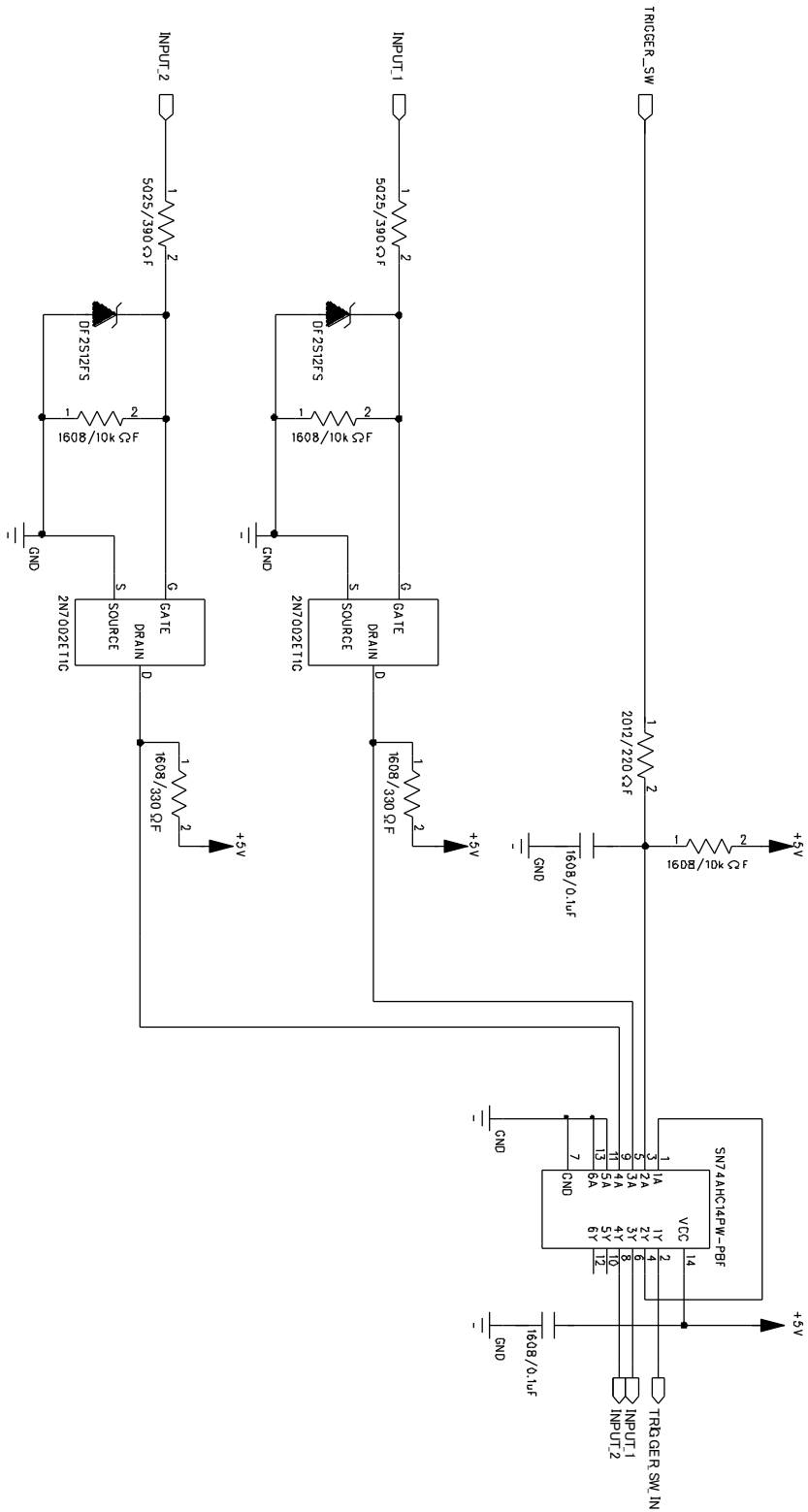

1.3.9 IRIG-sync Operation

This camera system supports IRIG-sync operation, in which the sensor drive signal is synchronized with the input of IRIG-B signal.

◆ How IRIG-sync operation works?

In IRIG-sync operation, the image sensor is driven by the timing signal shown below. Exposure to the sensor starts at the start of the IRIG-1PPS signal.

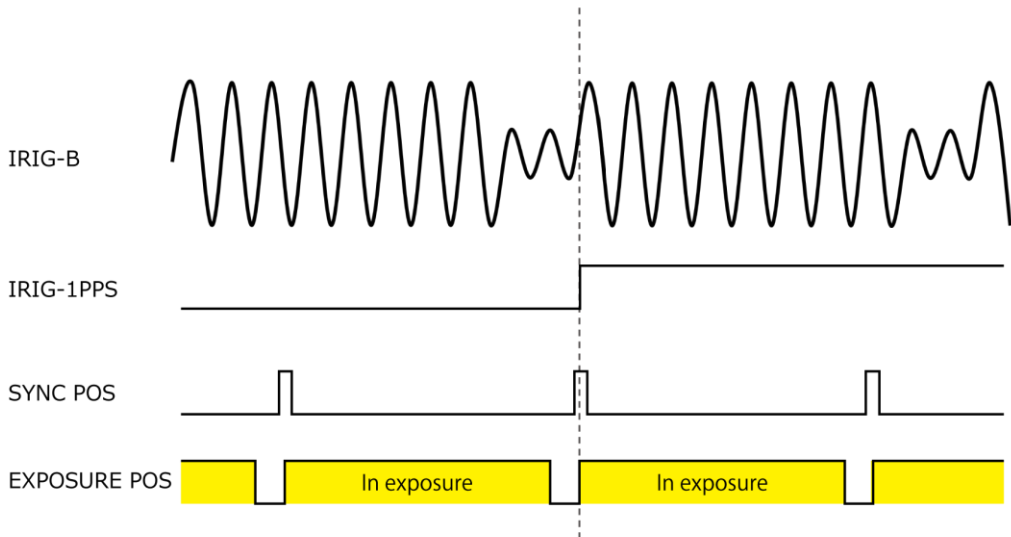

- IRIG-B : IRIG code that is input to the camera
- IRIG-1PPS : 1PPS timing of the IRIG code
- SYNC POS : Camera's vertical sync signal
- EXPOSURE POS : Exposure to the camera sensor

CAUTION

The IRIG signal must be input to the camera from the IRIG signal generator before enabling IRIG synchronous recording.

If the IRIG synchronous recording setting is preset, the IRIG signal must be input to the camera from the IRIG signal generator before the camera is activated.

1.3.10 Setting of Input/Output Signals and Sync Output Rate

With the system, you can set the signal delay time or pulse width for the various signals that are input and output. Pulse width and delay settings for the various signals to input/output are made with PFV. The content of each setting is listed in the chart below.

Setting Item	Setting Range (Value)
TRIG TTL IN DELAY	0 to 5 (sec) 100 nsec units
SYNC IN DELAY	0 to 1/frame rate (sec) 100 nsec units
GENERAL IN DELAY	0 to 5 (sec) 100 nsec units
TRIG OUT WIDTH	0 to 1/frame rate (sec) 100 nsec units
SYNC OUT DELAY	0 to 1/frame rate (sec) 100 nsec units
SYNC OUT WIDTH	0 to 500 (μ sec), 1/frame rate (sec) at 2,000 fps or higher 100 nsec units
EXPOSE OUT DELAY	0 to 1/frame rate (sec) 100 nsec units
Sync output rate	0.5, 1, 2, 4, 6, 8, 10, 20, 30 (* x1 is standard output)

◆ Sync output rate

Output a SYNC (vertical synchronization signal) from SYNC OUT that is X times SYNC.

■ Example: Sync output rate setting of 2.

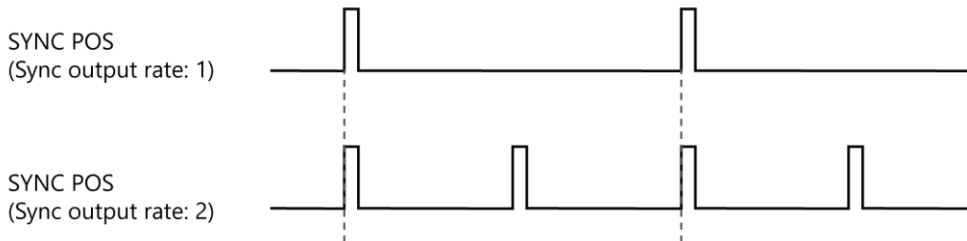

■ Example: Sync output rate setting of 4.

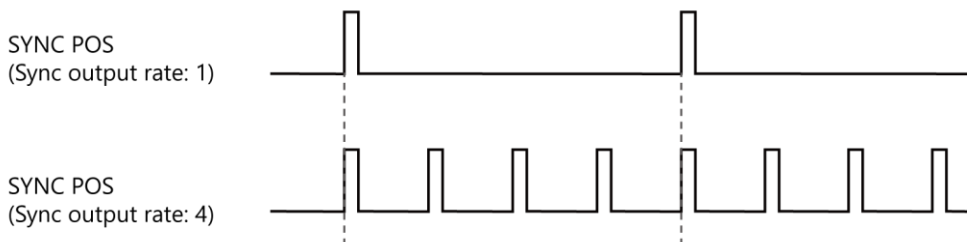



CAUTION

- An accurate frequency is output, but when Sync output rate is set to a large value with a high frame rate, the setting may result in frequency errors.
- There are following limitations in Sync output rate function (up to 160,000 fps for UX50)

Frame Rate		Restriction
	to 60,000 fps	No Limit
60,001 fps	to 90,000 fps	x30 is unavailable
90,001 fps	to 500,000 fps	x20 and x30 are unavailable
500,001 fps	to 700,000 fps	x8, x10, x20 and x30 are unavailable
700,001 fps	to 900,000 fps	x 6, x 8, x10, x20 and x30 are unavailable

- The signal input cannot be accepted during the delay period.
Example: If 100 msec of delay is applied, the trigger is recognized 100 msec after trigger input, but the trigger input during that 100 msec will be canceled.
- Export-controlled model type 200K is subject to certain restriction on the framing rate and shutter speed.



REFERENCE

Refer to “10.6.2 Signal Delay” of “Photron FASTCAM Viewer User’s Manual” for the details of the setup.

1.4 Device Connections

1.4.1 Minimum Equipment Connection

The minimum connection for using the camera is as follows.

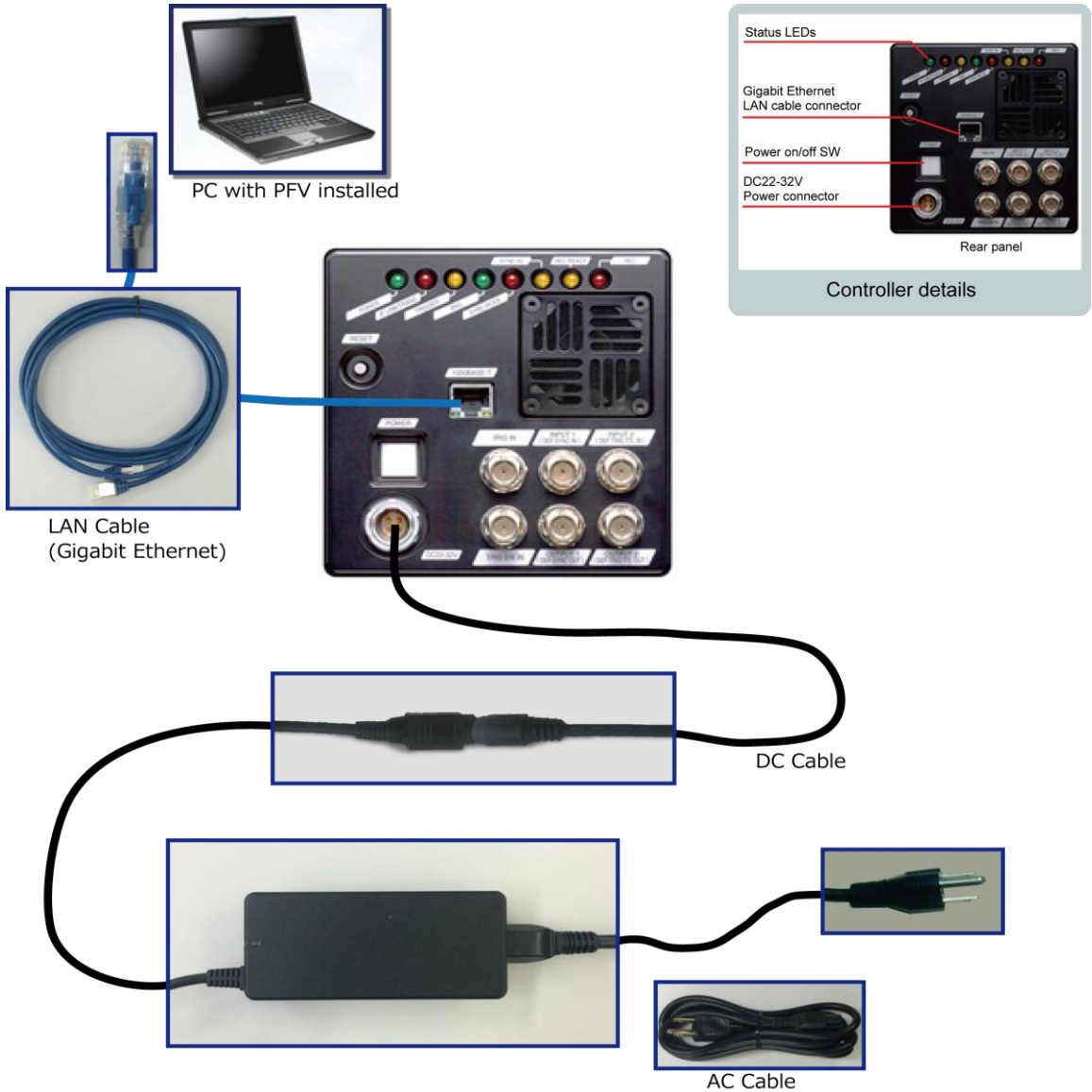

NOTE

- The FASTCAM camera supports 1000BASE-T (Gigabit Ethernet) only.
- If your PC supports 10BASE-T or 100BASE-T only, you need to install a 1000BASE-T interface board or use a switching hub that supports 10BASE-T, 100BASE-T and 1000BASE-T.

1.4.2 Connecting the AC Adapter

Connect the supplied AC adapter to the power supply.

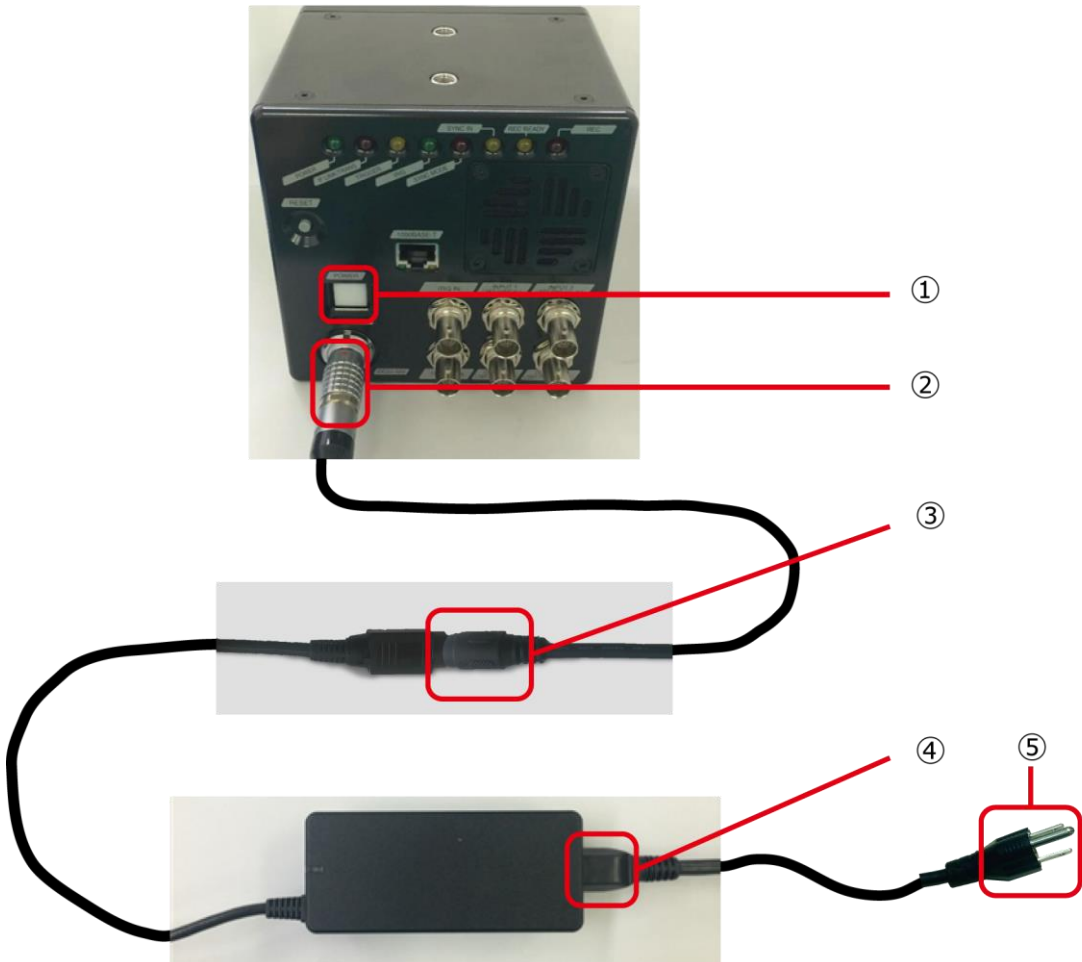

1. Confirm the Power SW is turned off.
2. Connect the DC cable to the “DC22-32V” connector on the back of the camera body.
3. Connect the DC cable to the AC adapter.
4. Connect the AC cable to the AC adapter.
5. Connect the AC cable to the power outlet.
6. Turn on the Power SW one the system.



REFERENCE

For the specification of the power supply which can be used, refer to “3.1.3 General Specifications”, on page 43.

1.4.3 Connecting a PC

This section explains the required setup when connecting the system to a PC.



Insert a LAN cable to “1000BASE-T” connector.

A bundled LAN cable may be different from the cable in the picture.

2

Chapter 2 Recording

This chapter explains operations related to recording.

2.1 Selecting Frame Rate / Resolution

Images can be recorded with the system from 50 fps to 4,000 fps (2,000 fps for UX50) using the full 1,280 x 1,024 pixel resolution of the image sensor. For frame rates higher than 4,000 fps (2,000 fps for UX50), high-speed recording is achieved by limiting the read area of the image sensor.

Restricting resolution enables higher speed recording. It also reduces data amount and then it enables longer time shooting/recording.

NOTE

Even if a limited horizontal resolution is applied, Frame Rate cannot be increased. This specification is different from other systems.

Refer to “3.1.5 Frame Rate and Resolution” for available frame rate.

CAUTION

Export-controlled model type 200K is subject to restriction on the framing rate.

2.1.1 Low Shutter Speed Mode

It is possible to configure the low shutter speed mode of below 50 fps (5 fps, 10 fps, 20 fps, 30 fps). This mode is disabled as a default setting. Detailed configuration is possible when it is enabled. However, please beware that the image quality lowers when this function is used.

REFERENCE

Refer to “10.7 Camera Option” of “Photron FASTCAM Viewer User’s Manual” for the details of the setup.

2.2 Selecting Shutter Speed

The shutter speed (Exposure time) is independent of the frame rate, and it is possible to control the exposure time in the frame using the electric shutter. By making an exposure that is of a shorter period than the frame rate, high-speed objects can be photographed blur-free.

The shortest setting value of shutter speed is 1/1,000,000 sec (approx 1 μ sec, 1/256,000 for UX50).



CAUTION

Export-controlled model type 200K is subject to restriction on the framing rate and shutter speed.



NOTE

A minimum exposure time depends on a set up frame rate.

- FASTCAM Mini UX100

Frame Rate	Limitation
50 fps to 160,000 fps	1/frame to 1/256,000 sec are selectable
200,000 fps	1/frame sec (3.76 μ sec) is only available
Type 200K	
256,000 fps	1/frame sec (2.72 μ sec) is only available
512,000 fps	1/frame sec (1.78 μ sec) is only available
800,000 fps	1/frame sec (1 μ sec) is only available

- FASTCAM Mini UX 50

Frame Rate	Limitation
50 fps to 160,000 fps	1/frame to 1/256,000 sec are selectable



REFERENCE

- Refer to “4.3 Setting Shooting Conditions” of “Photron FASTCAM Viewer User’s Manual” for the details of the setup.
- For more information of Shutter Speed, refer to “3.1.6 Shutter Speed List”, page 49.

3

Chapter 3 Product Specifications

This chapter explains the system's specifications.

3.1 Specifications

3.1.1 Product Specifications

Image Sensor	CMOS image sensor	
Sensor Resolution	1,280 x 1,024 pixels	
Pixel Size	10 μm	
Frame Rate	When full frame: FASTCAM Mini UX100 4,000 fps max. FASTCAM Mini UX50 2,000 fps max. When a frame segment: FASTCAM Mini UX100(type 800K) 800,000 fps max. FASTCAM Mini UX100(type 200K) 204,800 fps max. FASTCAM Mini UX50 160,000 fps max.	
Accuracy of frame rate	±50 ppm	
Lens Mount	G type F mount, C mount (optional)	
Recording Color Depth	Monochrome	12bit
	Color	RGB, each 12bit/8bit (Bayer color filter method)
Shutter Method	Electronic shutter	
Recording Method	IC memory	
Recording Memory Capacity	4 GB, 8 GB, 16 GB, 32GB	
Trigger Method	START, CENTER, END, MANUAL, RANDOM	
Gain Control	Controllable by software	
External Synchronization Input Signal	+3.3 to +12Vp-p, negative polarity/positive polarity (switchable) Variable frequency sync	
External Synchronization Output Signal	5 Vp-p, negative polarity/positive polarity (switchable)	
Trigger Input Signal	TTL (+3.3 to +12V) negative polarity/positive polarity, contact	
Other Output Signals	Other timing signal outputs	
External Control	Gigabit Ethernet I/F (PC)	
Video Output Signal	NONE	
Digital Interface	Gigabit Ether Port (1000BASE-T)	

3.1.2 Other Supported Function

Supported Function		
Variable Framerate/Resolution	Resolution Lock	Fan Control
Lens Control (optional)	IRIG Input	Variable Synchronization
Signal Delay Setting	Sync output rate	Event Marker
Shutter lock		

3.1.3 General Specifications

Environment Conditions	
Storage Temperature	-20°C to 60°C (No Condensation) -4°F to 140°F (No Condensation)
Storage Humidity	85% or less (No Condensation)
Operating Temperature	0 to 40°C (No Condensation) 32°F to 104°F (No Condensation)
Operating Humidity	85% or less (No Condensation)
Pollution degree	Degree 2 according to IEC60664-1
Overvoltage category	Category II according to IEC60664-1
Maximum use altitude	2,000 m or lower
Shock Resistance Performance	100G, 10msec, 6 axes, total 1,000 times
External Dimensions	
Camera Body	120.0 (H) x 120.0 (W) x 93.0 (D) mm, excluding protrusion 4.7" (W) x 4.7" (H) x 3.7" (D)
DC Power Supply	
Power Voltage	22V to 32 V
Power Consumption	40VA
Weight	
Camera Body	1.5 kg 3.3 lbs



Photron has verified two types of AC cables, type A (standard for Japan, USA, Canada, etc.) and type SE (standard for Germany, France, etc.). However, when those cables cannot properly receive power when plugged in, use the proper AC cable for the region's standards and verify that AC cable works properly.

For inquiries regarding the recommended AC cable for each region, contact that region's Photron branch office or the distributor.

3.1.4 AC Adapter

Manufacturer		POWER-WIN TECHNOLOGY CORP.
Type		PW-080A4-1Y240A
Rating	Input	AC100-240V, 50-60Hz, up to 2A
	Output	DC24V, 3.34A
Dimensions		40.0 (H) x 69.0 (W) x 132.0 (D) mm excluding protrusions
Weight		0.44 kg 0.9lbs

3.1.5 Frame Rate and Resolution

FASTCAM Mini UX100

◆ 1,280 x 1,024 to 1,280 x 120

Resolution \ Frame Rate (fps)	1,280 x 1,024	1,280 x 1,000	1,280 x 800	1,280 x 720	1,280 x 624	1,280 x 512	1,280 x 480	1,280 x 400	1,280 x 312	1,280 x 248	1,280 x 200	1,280 x 152	1,280 x 120
50*	✓	✓	✓	✓	✓	✓	✓	✓	✓	✓	✓	✓	✓
125	✓	✓	✓	✓	✓	✓	✓	✓	✓	✓	✓	✓	✓
250	✓	✓	✓	✓	✓	✓	✓	✓	✓	✓	✓	✓	✓
500	✓	✓	✓	✓	✓	✓	✓	✓	✓	✓	✓	✓	✓
1,000	✓	✓	✓	✓	✓	✓	✓	✓	✓	✓	✓	✓	✓
2,000	✓	✓	✓	✓	✓	✓	✓	✓	✓	✓	✓	✓	✓
3,200	✓	✓	✓	✓	✓	✓	✓	✓	✓	✓	✓	✓	✓
4,000	✓	✓	✓	✓	✓	✓	✓	✓	✓	✓	✓	✓	✓
5,000		✓	✓	✓	✓	✓	✓	✓	✓	✓	✓	✓	✓
6,250			✓	✓	✓	✓	✓	✓	✓	✓	✓	✓	✓
6,400				✓	✓	✓	✓	✓	✓	✓	✓	✓	✓
8,000					✓	✓	✓	✓	✓	✓	✓	✓	✓
8,192						✓	✓	✓	✓	✓	✓	✓	✓
10,000							✓	✓	✓	✓	✓	✓	✓
10,240							✓	✓	✓	✓	✓	✓	✓
12,500								✓	✓	✓	✓	✓	✓
16,000									✓	✓	✓	✓	✓
20,000										✓	✓	✓	✓
25,000											✓	✓	✓
32,000												✓	✓
40,000													✓
50,000													
64,000													
80,000													
100,000													
160,000													
200,000													
type 200K													
256,000													
512,000													
800,000													

The ✓ mark indicates a possible setting. Green items are the maximum resolution setting at that frame rate.

This table shows default settings. Even finer settings are possible with the variable setting feature.

*The resolutions of the low shutter speed modes (5, 10, 20 and 30 fps) are the same as 50 fps.

FASTCAM Mini UX100

◆ 1,280 x 96 to 1,280 x 16

Resolution Frame Rate (fps)	1,280 x 96	1,280 x 72	1,280 x 56	1,280 x 32	1,280 x 24	1,280 x 16
50*	✓	✓	✓	✓	✓	✓
125	✓	✓	✓	✓	✓	✓
250	✓	✓	✓	✓	✓	✓
500	✓	✓	✓	✓	✓	✓
1,000	✓	✓	✓	✓	✓	✓
2,000	✓	✓	✓	✓	✓	✓
3,200	✓	✓	✓	✓	✓	✓
4,000	✓	✓	✓	✓	✓	✓
5,000	✓	✓	✓	✓	✓	✓
6,250	✓	✓	✓	✓	✓	✓
6,400	✓	✓	✓	✓	✓	✓
8,000	✓	✓	✓	✓	✓	✓
8,192	✓	✓	✓	✓	✓	✓
10,000	✓	✓	✓	✓	✓	✓
10,240	✓	✓	✓	✓	✓	✓
12,500	✓	✓	✓	✓	✓	✓
16,000	✓	✓	✓	✓	✓	✓
20,000	✓	✓	✓	✓	✓	✓
25,000	✓	✓	✓	✓	✓	✓
32,000	✓	✓	✓	✓	✓	✓
40,000	✓	✓	✓	✓	✓	✓
50,000	✓	✓	✓	✓	✓	✓
64,000		✓	✓	✓	✓	✓
80,000			✓	✓	✓	✓
100,000				✓	✓	✓
160,000				✓	✓	
200,000					✓	✓
type 200K						
256,000						✓
512,000						
800,000						

The ✓ mark indicates a possible setting. Light blue items are the maximum resolution setting at that frame rate.

This table shows default settings. Even finer settings are possible with the variable setting feature.

* The resolutions of the low shutter speed modes (5, 10, 20 and 30 fps) are the same as 50 fps.

FASTCAM Mini UX100

◆ 1,024 x 1,024 to 640 x 8

Resolution Frame Rate (fps)	1,024 x 1,024	1,024 x 576	896 x 896	896 x 720	896 x 488	768 x 768	768 x 512	640 x 480	640 x 320	640 x 8
50*	✓	✓	✓	✓	✓	✓	✓	✓	✓	✓
125	✓	✓	✓	✓	✓	✓	✓	✓	✓	✓
250	✓	✓	✓	✓	✓	✓	✓	✓	✓	✓
500	✓	✓	✓	✓	✓	✓	✓	✓	✓	✓
1,000	✓	✓	✓	✓	✓	✓	✓	✓	✓	✓
2,000	✓	✓	✓	✓	✓	✓	✓	✓	✓	✓
3,200	✓	✓	✓	✓	✓	✓	✓	✓	✓	✓
4,000	✓	✓	✓	✓	✓	✓	✓	✓	✓	✓
5,000		✓	✓	✓	✓	✓	✓	✓	✓	✓
6,250		✓		✓	✓	✓	✓	✓	✓	✓
6,400		✓		✓	✓	✓	✓	✓	✓	✓
8,000		✓			✓		✓	✓	✓	✓
8,192		✓			✓		✓	✓	✓	✓
10,000					✓			✓	✓	✓
10,240								✓	✓	✓
12,500									✓	✓
16,000										✓
20,000										✓
25,000										✓
32,000										✓
40,000										✓
50,000										✓
64,000										✓
80,000										✓
100,000										✓
160,000										✓
200,000										✓
type 200K										
256,000										✓
512,000										✓
800,000										✓

The ✓ mark indicates a possible setting. Light blue items are the maximum resolution setting at that frame rate.

This table shows default settings. Even finer settings are possible with the variable setting feature.

* The resolutions of the low shutter speed modes (5, 10, 20 and 30 fps) are the same as 50 fps.

FASTCAM Mini UX50

◆ 1,280 x 1,024 to 1,280 x 8

Resolution Frame Rate (fps)	1,280 x 1,024	1,280 x 800	1,280 x 720	1,280 x 512	1,280 x 488	1,280 x 296	1,280 x 240	1,280 x 120	1,280 x 96	1,280 x 56	1,280 x 48	1,280 x 24	1,280 x 8
50*	✓	✓	✓	✓	✓	✓	✓	✓	✓	✓	✓	✓	✓
125	✓	✓	✓	✓	✓	✓	✓	✓	✓	✓	✓	✓	✓
250	✓	✓	✓	✓	✓	✓	✓	✓	✓	✓	✓	✓	✓
500	✓	✓	✓	✓	✓	✓	✓	✓	✓	✓	✓	✓	✓
1,000	✓	✓	✓	✓	✓	✓	✓	✓	✓	✓	✓	✓	✓
2,000	✓	✓	✓	✓	✓	✓	✓	✓	✓	✓	✓	✓	✓
2,500		✓	✓	✓	✓	✓	✓	✓	✓	✓	✓	✓	✓
3,200			✓	✓	✓	✓	✓	✓	✓	✓	✓	✓	✓
4,000				✓	✓	✓	✓	✓	✓	✓	✓	✓	✓
5,000					✓	✓	✓	✓	✓	✓	✓	✓	✓
5,120						✓	✓	✓	✓	✓	✓	✓	✓
8,000							✓	✓	✓	✓	✓	✓	✓
10,000								✓	✓	✓	✓	✓	✓
20,000									✓	✓	✓	✓	✓
25,000										✓	✓	✓	✓
40,000											✓	✓	✓
50,000												✓	✓
80,000													✓
100,000													✓
160,000													✓

The ✓ mark indicates a possible setting. Light blue items are the maximum resolution setting at that frame rate.

This table shows default settings. Even finer settings are possible with the variable setting feature.

* The resolutions of the low shutter speed modes (5, 10, 20 and 30 fps) are the same as 50 fps.

FASTCAM Mini UX50

◆ 1,024 x 1,024 to 640 x 240

Resolution Frame Rate (fps)	1,024 x 1,024	1,024 x 576	896 x 896	896 x 720	896 x 488	768 x 768	768 x 512	640 x 480	640 x 240
50*	✓	✓	✓	✓	✓	✓	✓	✓	✓
125	✓	✓	✓	✓	✓	✓	✓	✓	✓
250	✓	✓	✓	✓	✓	✓	✓	✓	✓
500	✓	✓	✓	✓	✓	✓	✓	✓	✓
1,000	✓	✓	✓	✓	✓	✓	✓	✓	✓
2,000	✓	✓	✓	✓	✓	✓	✓	✓	✓
2,500		✓	✓	✓	✓	✓	✓	✓	✓
3,200		✓		✓	✓	✓	✓	✓	✓
4,000		✓			✓		✓	✓	✓
5,000					✓			✓	✓
5,120								✓	✓
8,000									✓
10,000									✓
20,000									
25,000									
40,000									
50,000									
80,000									
100,000									
160,000									

The ✓ mark indicates a possible setting. Light blue items are the maximum resolution setting at that frame rate.

This table shows default settings. Even finer settings are possible with the variable setting feature.

* The resolutions of the low shutter speed modes (5, 10, 20 and 30 fps) are the same as 50 fps.

3.1.6 Shutter Speed List

FASTCAM Mini UX100

Shutter Speed		
50 *	6,250	40,960
125 *	6,400	50,000
250 *	8,000	51,200
500 *	8,192	64,000
640 *	10,000	80,000
800 *	10,240	81,920
1,000	12,500	100,000
1,250	12,800	102,400
1,600	16,000	128,000
2,000	20,000	160,000
2,500	20,480	163,840
3,125	25,000	200,000
3,200	25,600	204,800
4,000	32,000	256,000
5,000	32,768	

FASTCAM Mini UX50

Shutter Speed		
50 *	5,120	32,768
125 *	6,250	40,000
250 *	6,400	40,960
500 *	8,000	50,000
640 *	8,192	51,200
800 *	10,000	64,000
1,000	10,240	80,000
1,250	12,500	81,920
1,600	12,800	100,000
2,000	16,000	102,400
2,500	20,000	128,000
3,125	20,480	160,000
3,200	25,000	256,000
4,000	25,600	
5,000	32,000	

The unit in the chart is 1/x s

* These are the shutter speeds that can be chosen when the low shutter speed modes are used.



NOTE

- These shutter speeds can be selected at 50 to 160,000 fps.
- In addition, 1/frame sec is selectable at all of frame rates.



CAUTION

Export-controlled model type 200K is subject to restriction on the shutter speed.

3.1.7 Recordable Frames / Resolution

FASTCAM Mini UX100

Resolution	4GB model Rec. Frames	8GB model Rec. Frames	16GB model Rec. Frames	32GB model Rec. Frames
1,280×1,024	2,180	4,365	8,734	17,472
1,280×1,000	2,232	4,469	8,943	17,891
1,280×800	2,791	5,587	11,179	22,364
1,280×720	3,101	6,208	12,421	24,849
1,280×616	3,624	7,256	14,519	29,044
1,280×512	4,361	8,730	17,468	34,944
1,280×480	4,651	9,312	18,632	37,274
1,280×400	5,582	11,174	22,359	44,729
1,280×312	7,156	14,326	28,665	57,344
1,280×248	9,003	18,023	36,063	72,143
1,280×200	11,164	22,349	44,718	89,458
1,280×152	14,689	29,406	58,840	117,707
1,280×120	18,607	37,248	74,531	149,096
1,280×96	23,259	46,560	93,164	186,370
1,280×72	31,012	62,080	124,218	248,494
1,280×56	39,872	79,818	159,709	319,492
1,280×32	69,777	139,682	279,492	559,112
1,280×24	93,036	186,242	372,656	745,483
1,280×16	139,554	279,364	558,984	1,118,225
1,024×1,024	2,725	5,456	10,917	10,989
1,024×576	4,845	9,700	19,409	38,827
896×896	3,560	7,126	14,259	28,526
896×720	4,430	8,868	17,745	35,499
896×48	6,536	13,084	26,181	532,488
768×768	4,845	9,700	19,409	38,827
768×512	7,268	14,550	29,113	58,240
640×480	9,303	18,624	37,265	74,548
640×320	13,955	27,936	55,898	111,822
640×8	558,216	1,117,457	2,235,938	4,472,900

* Recording Time = Rec. Frames x 1/frame rate (fps)

FASTCAM Mini UX50

Resolution	4GB model Rec. Frames	8GB model Rec. Frames	16GB model Rec. Frames	32GB model Rec. Frames
1,280×1,024	2,180	4,365	8,734	17,472
1,280×800	2,791	5,587	11,179	22,364
1,280×720	3,101	6,208	12,421	24,849
1,280×512	4,361	8,730	17,468	34,944
1,280×488	4,575	9,159	18,327	36,663
1,280×296	7,543	15,100	30,215	60,444
1,280×240	9,307	18,627	37,269	74,548
1,280×120	18,607	37,248	74,531	149,096
1,280×96	23,259	46,560	93,164	186,370
1,280×56	39,872	79,818	159,709	319,492
1,280×48	46,518	93,121	186,328	372,741
1,280×24	93,036	186,242	372,656	745,483
1,280×8	279,108	558,728	1,117,969	2,236,450
1,024×1,024	2,725	5,456	10,917	21,840
1,024×576	4,845	9,700	19,409	38,827
896×896	3,560	7,126	14,259	28,526
896×720	4,430	8,868	17,745	35,499
896×488	6,536	13,084	26,181	52,375
768×768	4,845	9,700	19,409	38,827
768×512	7,268	14,550	29,113	58,240
640×480	9,303	18,624	37,265	74,548
640×240	18,607	37,248	74,531	149,096

*Recording Time = Rec. Frames x 1/frame rate (fps)

3.1.8 Recordable Time / Resolution

FASTCAM Mini UX100

Resolution	MAX FrameRate	4GB model Rec. Time	8GB model Rec. Time	16GB model Rec. Time	32GB model Rec. Time
1,280×1,024	4,000	0.55	1.09	2.18	4.36
1,280×1,000	5,000	0.45	0.89	1.79	3.57
1,280×800	6,250	0.45	0.89	1.79	3.57
1,280×720	6,400	0.48	0.97	1.94	3.88
1,280×616	8,000	0.45	0.91	1.81	3.63
1,280×512	8,192	0.53	1.07	2.13	4.26
1,280×480	10,000	0.47	0.93	1.86	3.72
1,280×480	10,240	0.45	0.91	1.82	3.64
1,280×400	12,500	0.45	0.89	1.79	3.57
1,280×312	16,000	0.45	0.90	1.79	3.58
1,280×248	20,000	0.45	0.90	1.80	3.60
1,280×200	25,000	0.45	0.89	1.79	3.57
1,280×152	32,000	0.46	0.92	1.84	3.67
1,280×120	40,000	0.47	0.93	1.86	3.72
1,280×96	50,000	0.47	0.93	1.86	3.72
1,280×72	64,000	0.48	0.97	1.94	3.88
1,280×56	80,000	0.50	1.00	2.00	3.99
1,280×32	100,000	0.70	1.40	2.79	5.59
1,280×24	160,000	0.58	1.16	2.33	4.65
1,280×24	200,000	0.47	0.93	1.86	3.72
1,024×1,024	4,000	0.68	1.36	2.73	5.46
1,024×576	8,192	0.59	1.18	2.37	4.74
896×896	5,000	0.71	1.43	2.85	5.70
896×720	6,400	0.69	1.39	2.77	5.54
896×488	10,000	0.65	1.31	2.62	5.23
768×768	6,400	0.76	1.52	3.03	6.06
768×512	8,192	0.89	1.78	3.55	7.11
640×480	10,240	0.91	1.82	3.64	7.28
640×320	12,500	1.12	2.23	4.47	8.94
Type 200K					
1,280 x 16	256,000	0.55	1.09	2.18	4.36
640 x 8	512,000	1.09	2.18	4.37	8.73
640 x 8	800,000	0.70	1.40	2.79	5.59

The unit in the chart is sec

FASTCAM Mini UX50

Resolution	MAX FrameRate	4GB model Rec. Time	8GB model Rec. Time	16GB model Rec. Time	32GB model Rec. Time
1,280×1,024	2,000	1.09	2.18	4.37	8.73
1,280×800	2,500	1.12	2.23	4.47	8.94
1,280×720	3,200	0.97	1.94	3.88	7.76
1,280×512	4,000	1.09	2.18	4.37	8.73
1,280×488	5,000	0.92	1.83	3.67	7.33
1,280×296	8,192	0.92	1.84	3.69	7.37
1,280×240	10,240	0.91	1.82	3.64	7.28
1,280×120	20,480	0.91	1.82	3.64	7.28
1,280×96	25,600	0.91	1.82	3.64	7.28
1,280×56	40,960	0.97	1.95	3.90	7.80
1,280×48	51,200	0.91	1.82	3.64	7.28
1,280×24	102,400	0.91	1.82	3.64	7.28
1,280×8	160,000	1.74	3.49	6.99	13.97
1,024×1,024	2,000	1.36	2.73	5.46	10.92
1,024×576	4,000	1.21	2.43	4.85	9.70
896×896	2,500	1.42	2.85	5.70	11.41
896×720	3,200	1.38	2.77	5.55	11.09
896×488	5,000	1.31	2.62	5.24	10.47
768×768	3,200	1.51	3.03	6.07	12.13
768×512	4,000	1.82	3.64	7.28	14.56
640×480	5,120	1.82	3.64	7.28	14.56
640×240	10,240	1.82	3.64	7.28	14.56

The unit in the chart is sec

3.1.9 Timing Diagram

This is a timing diagram that describes the relationship between the input and output signals to the product and the timing to start recording.

This timing diagram is a schematic diagram, and more detailed operations are described in the following pages.

Use it as a reference when linking with other devices or building a system.



NOTE

- This timing diagram is a schematic diagram and does not represent the accuracy of the actual signal.
- “n frame” means the number of frames that can be recorded.
- For more detailed information, refer to “5.1 Contact Information” on page 67 and contact Photron.

■ Relationship between SYNC POS and EXPOSE POS

The exposure (EXPOSE) of this system is linked to the SYNC signal (camera drive), and when the shutter is released to shorten the exposure, the exposure is shortened based on the rising edge of SYNC POS.

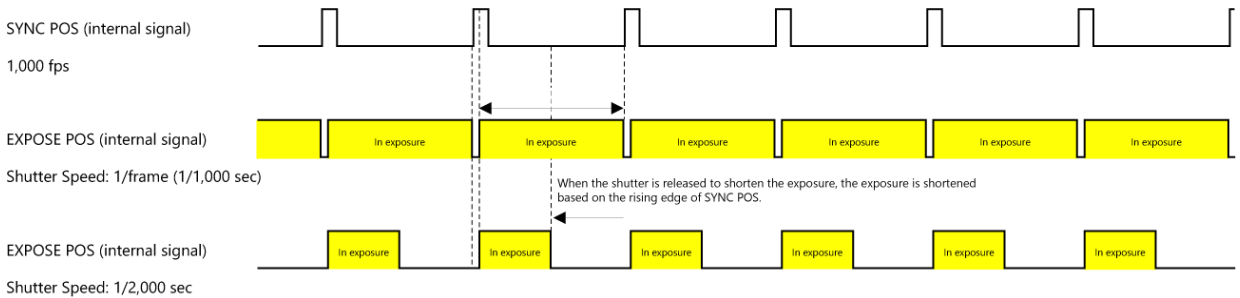

■ Start / Random Trigger Mode

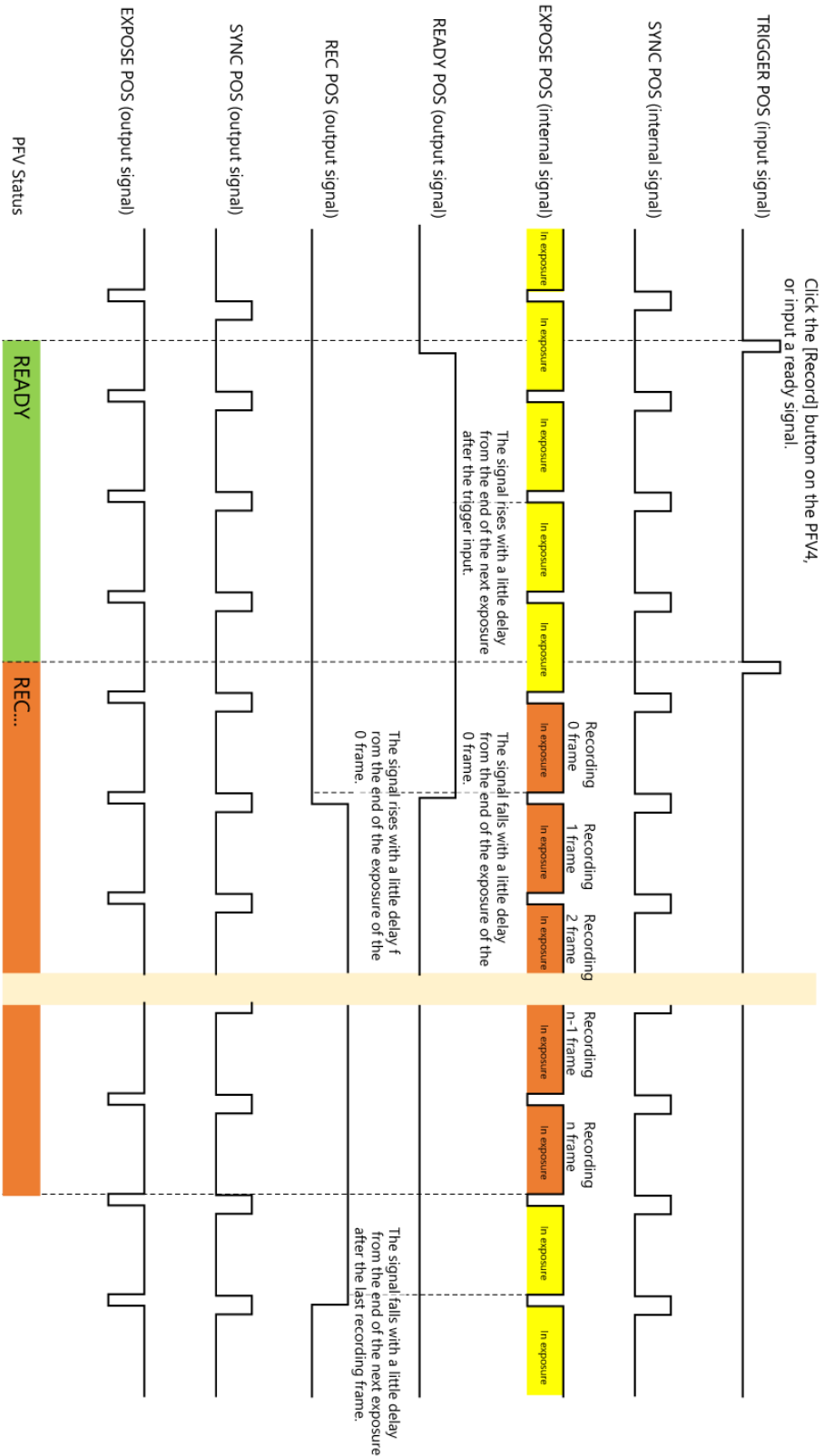

■ Center / Manual Trigger Mode

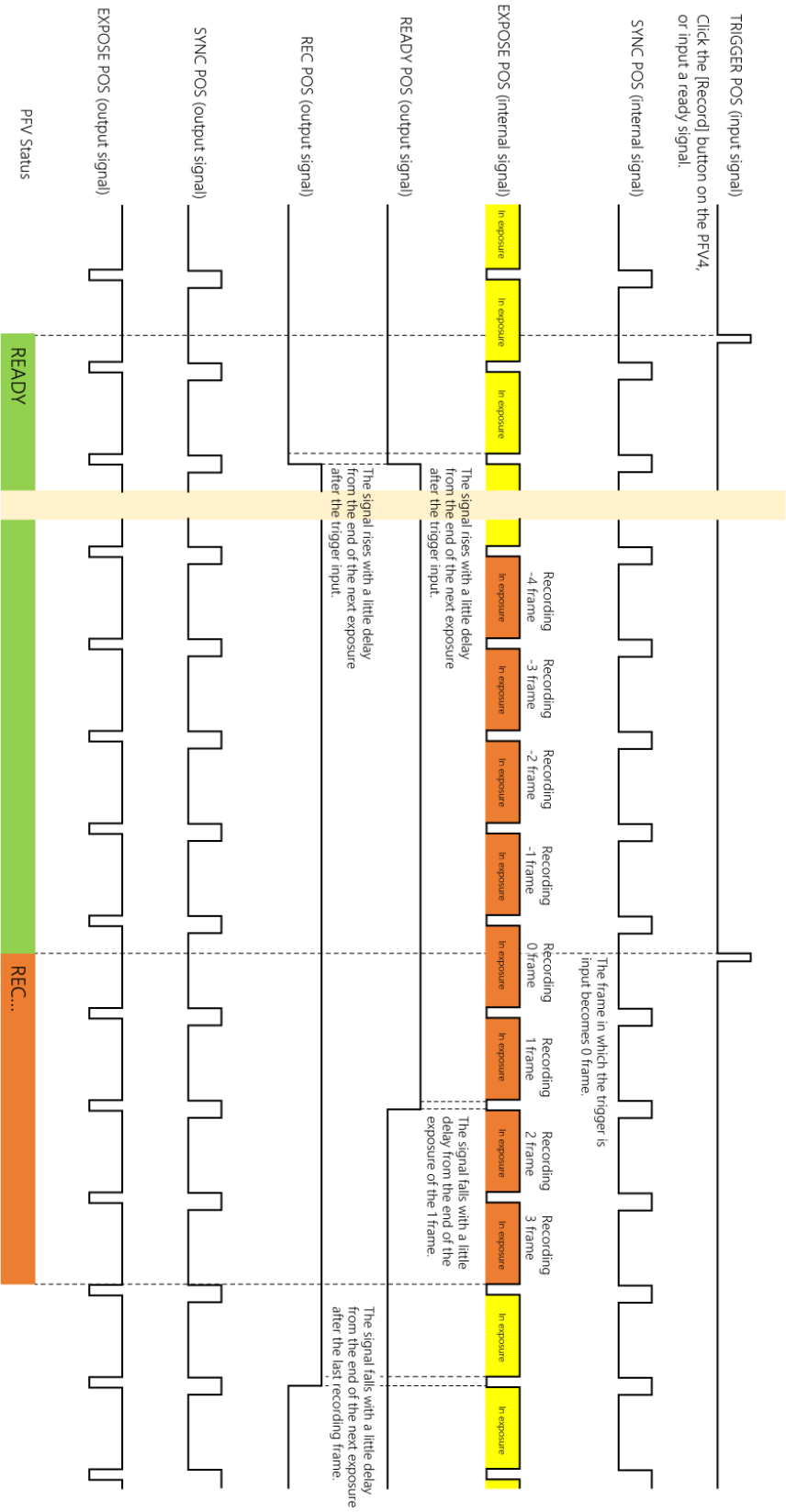

■ End Trigger Mode

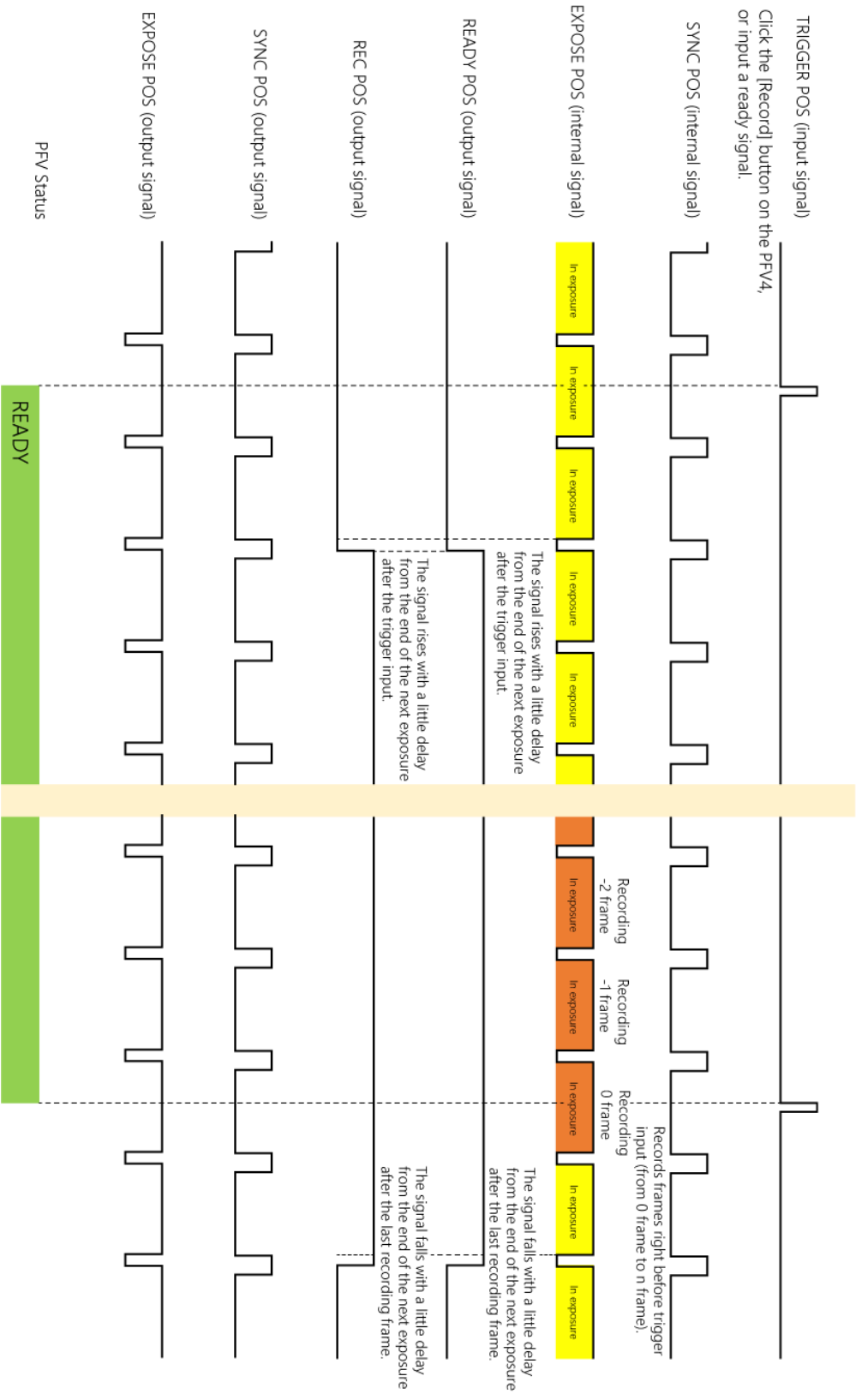

3.1.10 Inter Frame Time

When the shutter speed is set to 1/frame, the shutter is always open numerically, but due to the characteristics of electronic shutters, a reset time is required and there is a small period of time when no exposure occurs. This time is referred to as “Inter Frame Time”.

The Inter Frame Time occurs only at 1/frame and does not occur when the shutter is released.

This time can also be checked by setting the shutter speed display to “0.xxx msec” setting in PFV4.

The Inter Frame Time of this system are shown in the timing diagram below and vary depending on the frame rate conditions.

Refer to the table below for specific values.

■ Overview diagrams of Inter Frame Time

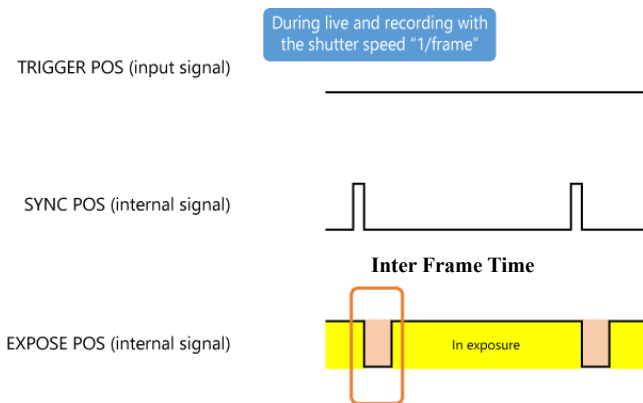

■ Enlarged diagrams of Inter Frame Time

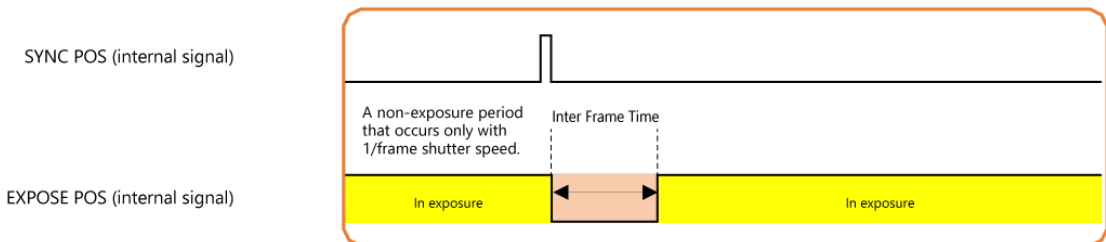

■ Interframe Time for each frame rate

Inter frame time is the shortest duration without exposure between frames.

Frame Rate	Interframe Time
Under 200,000 fps	1.24 μsec
200,000 fps	1.24 μsec
256,000 fps	1.184 μsec
512,000 fps	234 nsec
800,000 fps	234 nsec

3.2 Dimensions

3.2.1 Camera Body

- ◆ FASTCAM Mini UX50/100 (G type F mount)
(mm)

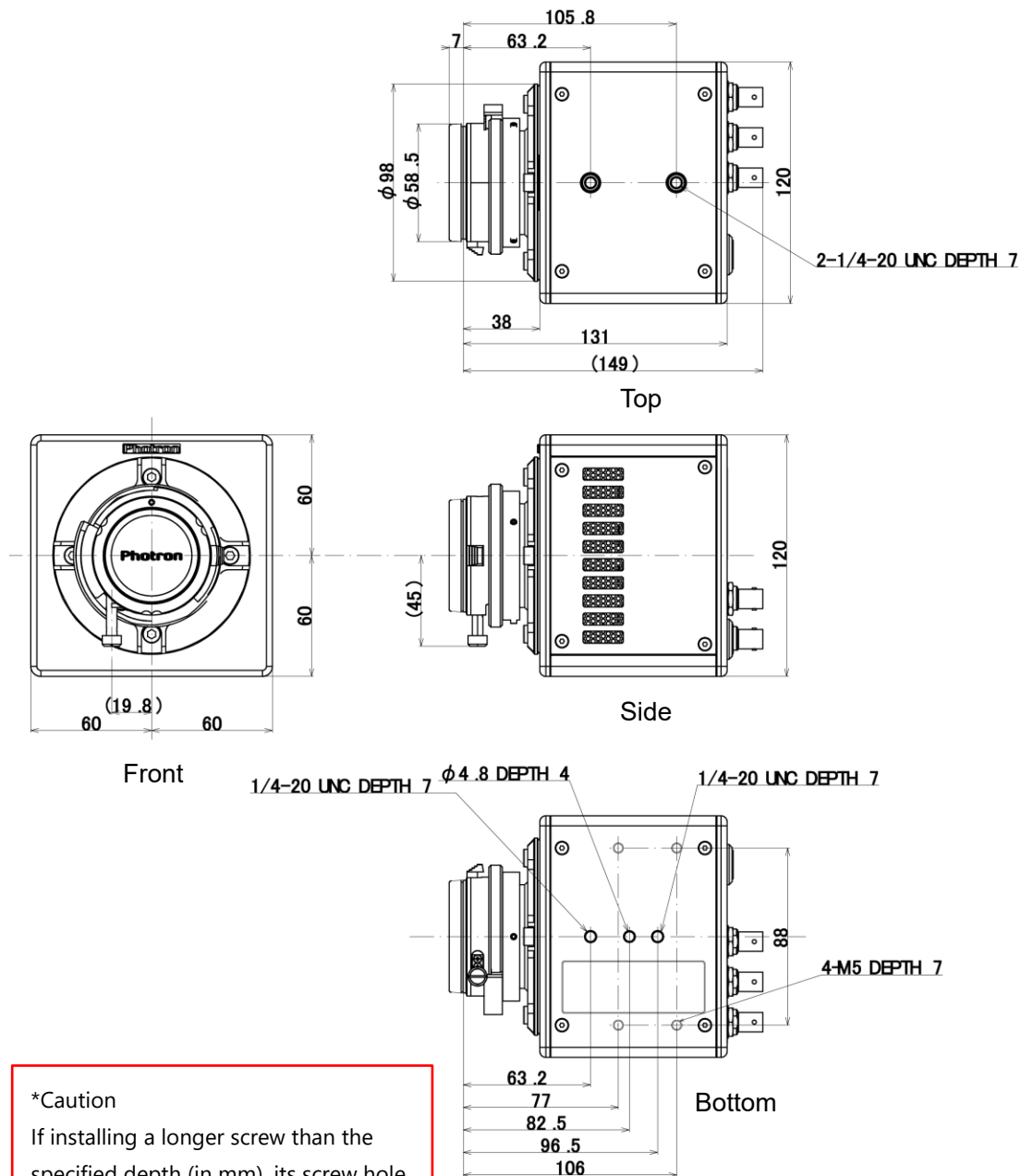

*Caution
If installing a longer screw than the specified depth (in mm), its screw hole or the camera may be damaged.

◆ FASTCAM Mini UX50/100 (C mount)
(mm)

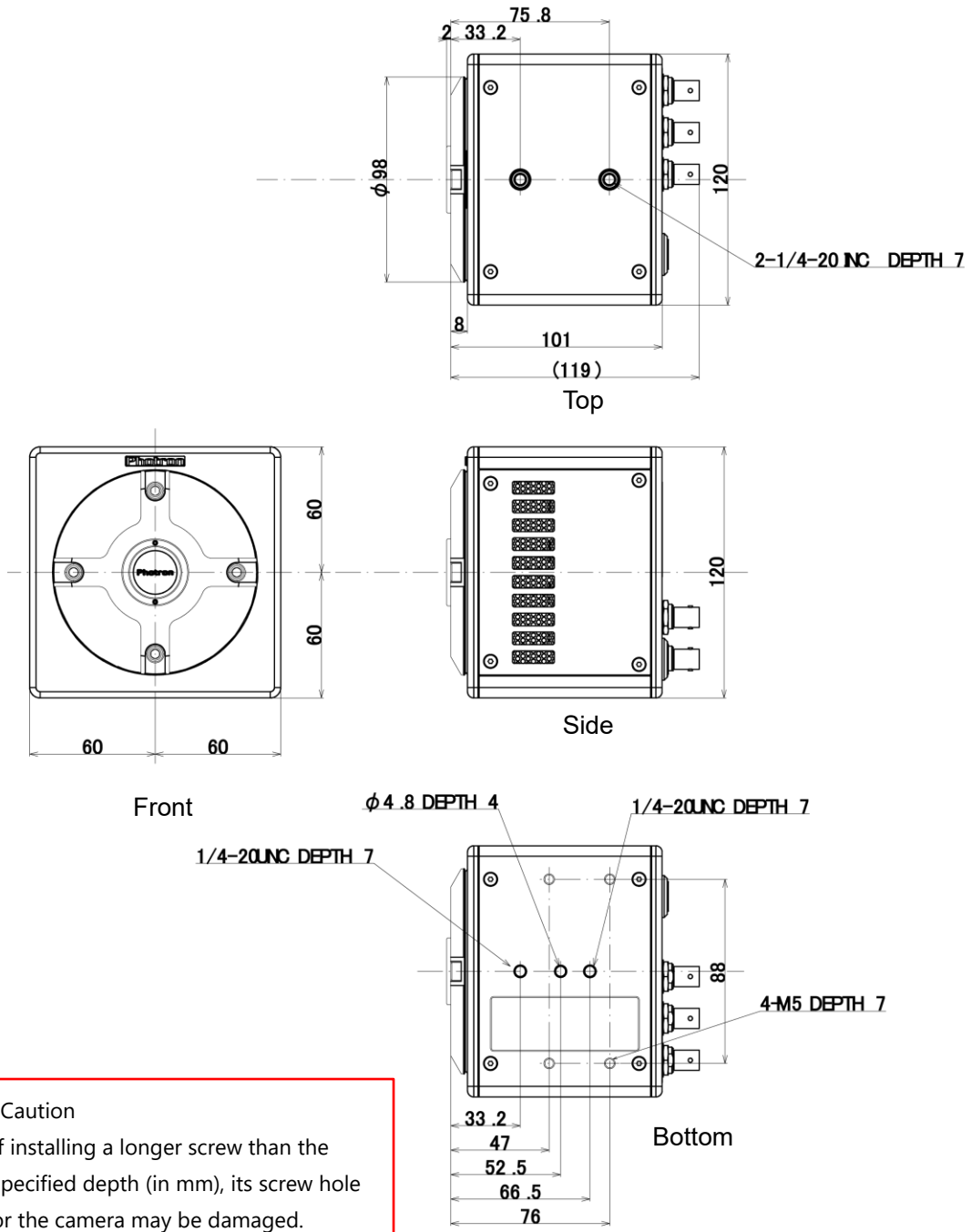

***Caution**
If installing a longer screw than the specified depth (in mm), its screw hole or the camera may be damaged.

3.2.2 Sensor Position

- ◆ FASTCAM Mini UX50/100 (G type F mount)
(mm)

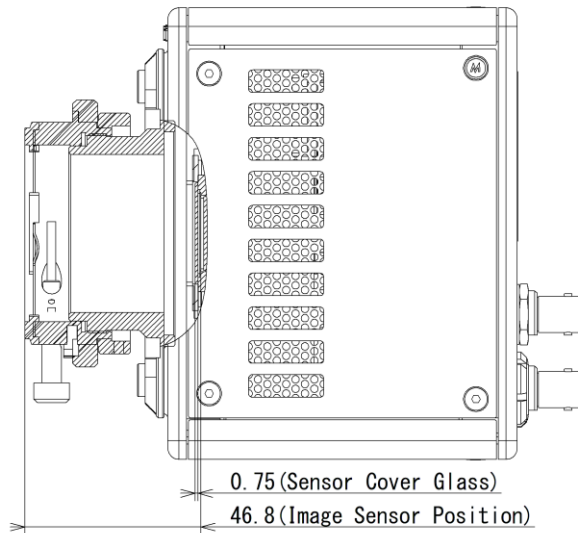

- ◆ FASTCAM Mini UX50/100 (G type F mount)
(mm)

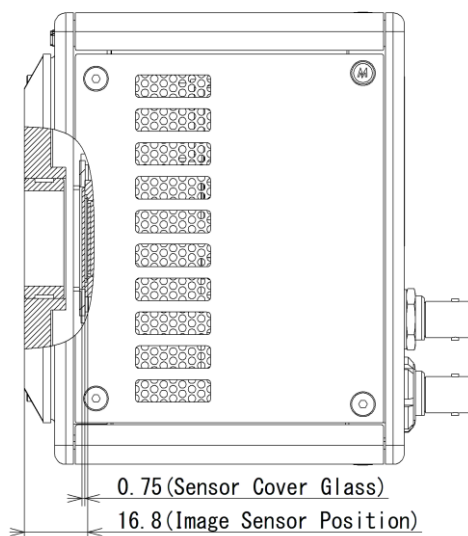

3.2.3 AC Adapter

(mm)

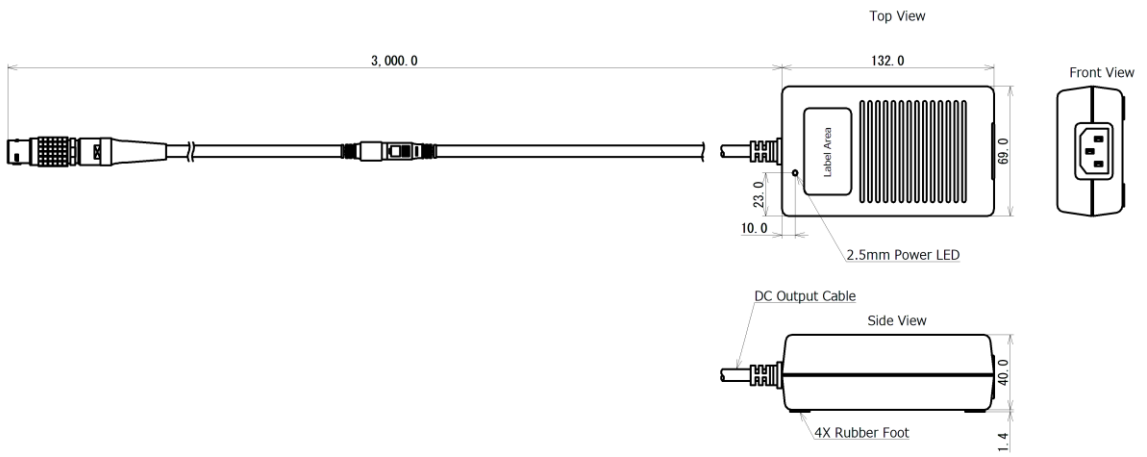

4

Chapter 4 Warranty

This chapter explains about the warranty.

4.1 About the Warranty

This system has been shipped having undergone rigorous testing. However, in the unlikely event that it malfunctions due to a manufacturing defect, it will be repaired, at no charge, within the warranty period.

◆ Warranty Exceptions

The following exceptions will result in fee-based repair, even within the warranty period.

1. Damage or malfunction as a result of fire, earthquake, water damage, lightning, other natural disasters, pollution, or the effects of abnormal voltage.
2. Damage or malfunction as a result of dropping or mishandling during shipment or when moving after purchase or misuse.
3. Consumable goods (cables)
4. When repair, adjustment, or alternation done by an entity other than Photron service has been performed on the system, or damage or malfunction that is determined to be attributed to a fault in the use the product.

For inquires related to malfunction, contact the dealer where the product was purchased, or the nearest Photron office.



REFERENCE

For inquires related to our product, refer to “5.1 Contact Information” page 67.

5

Chapter 5 Contacting Photron

This chapter lists the contact information to use when contacting Photron if the system malfunctions or if a portion of the manual is unclear.

5.1 Contact Information

For inquiries related to FASTCAM Mini UX, contact Photron at one of the contact points listed below. Additionally, the following items will be required for verification when inquiring. You are kindly asked to prepare them in advance.

Items Verified	Required Information
Contact Information	Company, school or organization name, customer contact name, contact phone number, contact e-mail address.
Product Name	FASTCAM Mini UX50/100
Serial Number	Shown in the nameplate seal.
Condition of the system, nature of problem, etc.	

Contact Information	
In Americas and Antipodes	PHOTRON USA, INC. 9520 Padgett Street, Suite 110, San Diego, CA 92126-4426, USA Phone: +1 (800) 585 2129 or +1 (858) 684 3555 Fax: +1 (858) 684 3558 E-mail: image@photron.com Web: www.photron.com
In UK, Africa and India	PHOTRON (EUROPE) LIMITED The Barn, Bottom Road, West Wycombe, Buckinghamshire HP14 4BS, U.K. Phone: +44 (0) 1494 48 1011 Fax: +44 (0) 1494 48 7011 E-mail: image@photron.com Web: www.photron.com
In Europe outside the UK	Photron Deutschland GmbH Ziegelweg 3, 72764 Reutlingen, Germany Phone: +49 (0) 7121 699 7950 Fax: +49 (0) 7121 699 7943 E-mail: image@photron.com Web: www.photron.com
In China	PHOTRON (SHANGHAI) LIMITED Room 1601, No. 1, Lane 600, Tianshan Road, Changning District, Shanghai (TONGDA PROPERTY BUILDING) 200051 China Phone: +86 (21) 5268 3700 Fax: +86 (21) 5268 3702 E-mail: info@photron.cn.com Web: www.photron.cn.com
In other areas	PHOTRON LIMITED 21F, Jinbocho Mitsui Bldg., 1-105 Kanda Jimbocho, Chiyoda-Ku, Tokyo 101-0051, Japan Phone: +81 (3) 3518 6271 Fax: +81 (3) 3518 6279 E-mail: image@photron.co.jp Web: www.photron.co.jp

A

A. Appendix

A.1. Reference Information



CAUTION

The spectrum response curve and the quantum efficiency curve are nominal (reference) data of the image sensor device.

A.1.1 Mini UX50 Relative Spectral Response (monochrome)

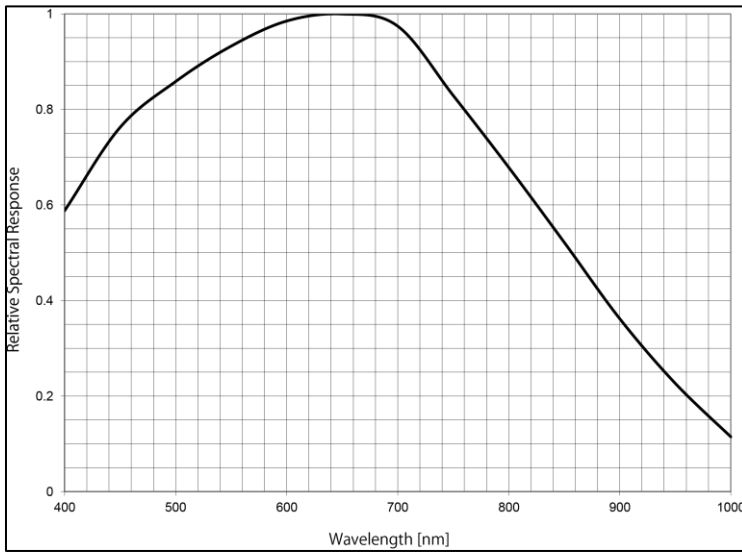

A.1.2 Mini UX50 Quantum Efficiency (monochrome)

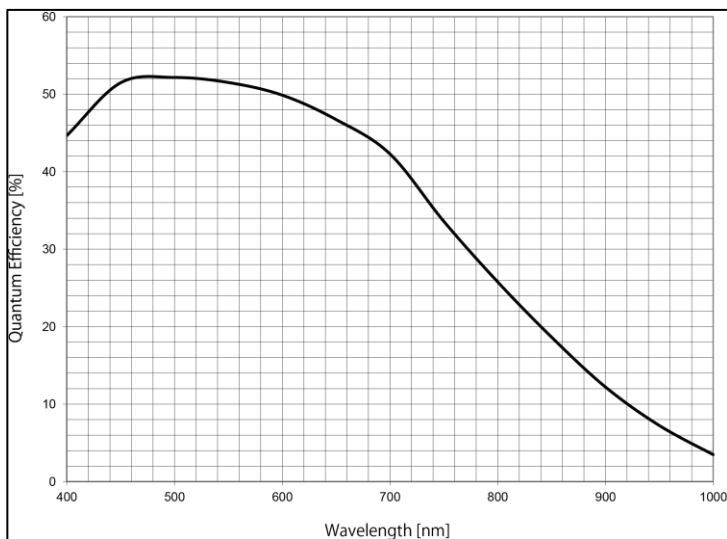

A.1.3 Mini UX100 Relative Spectral Response (monochrome)

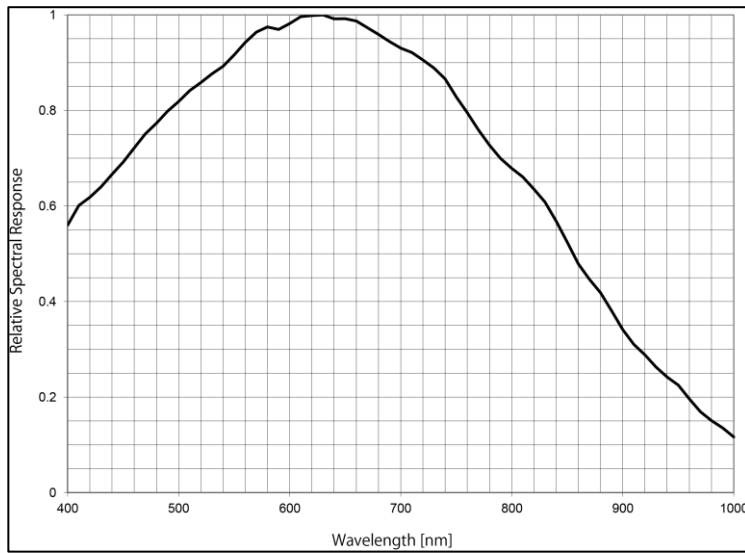

A.1.4 Mini UX100 Quantum Efficiency (monochrome)

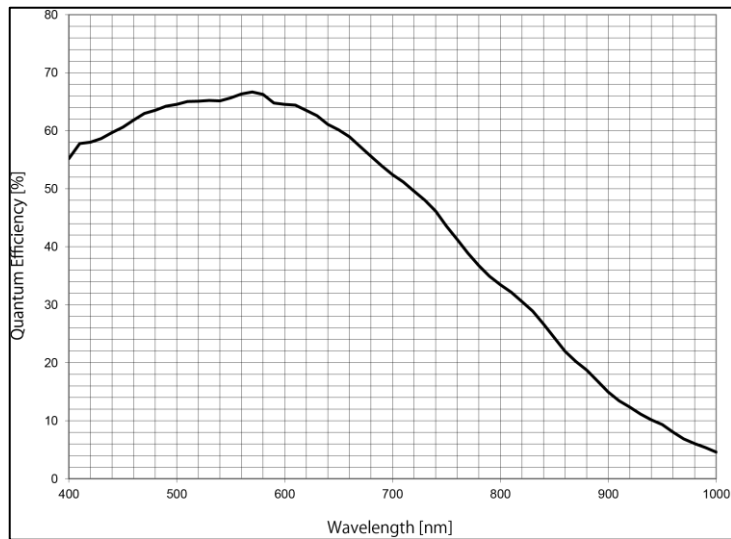

A.1.5 Mini UX50 Relative Spectral Response (color)

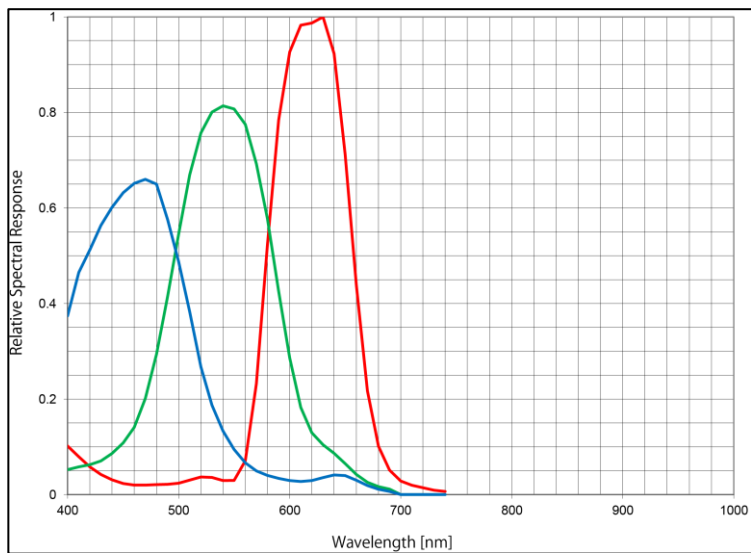

A.1.6 Mini UX50 Quantum Efficiency (color)

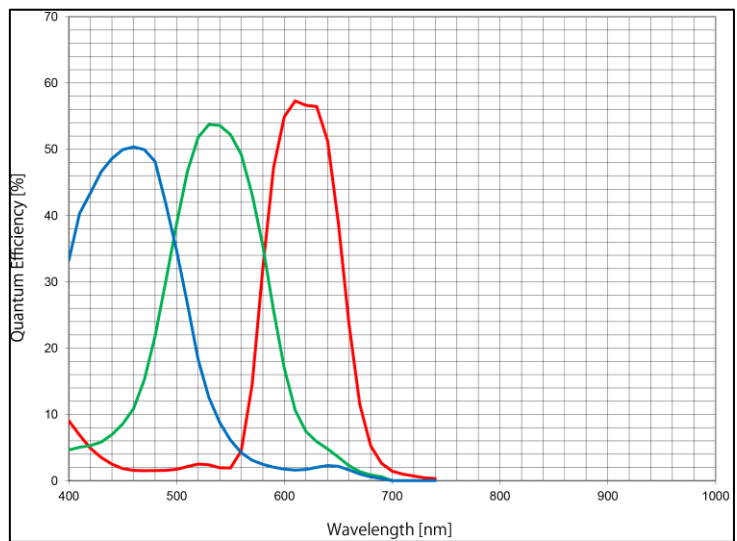

A.1.7 Mini UX100 Relative Spectral Response (color)

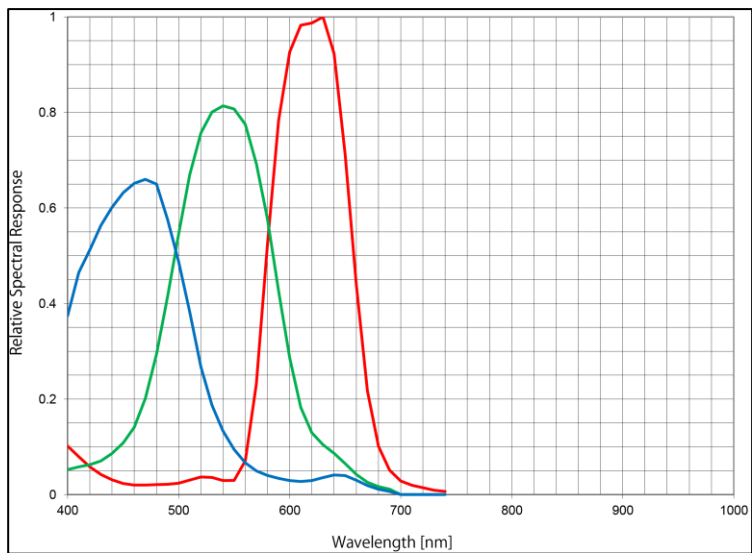

A.1.8 Mini UX100 Quantum Efficiency (color)

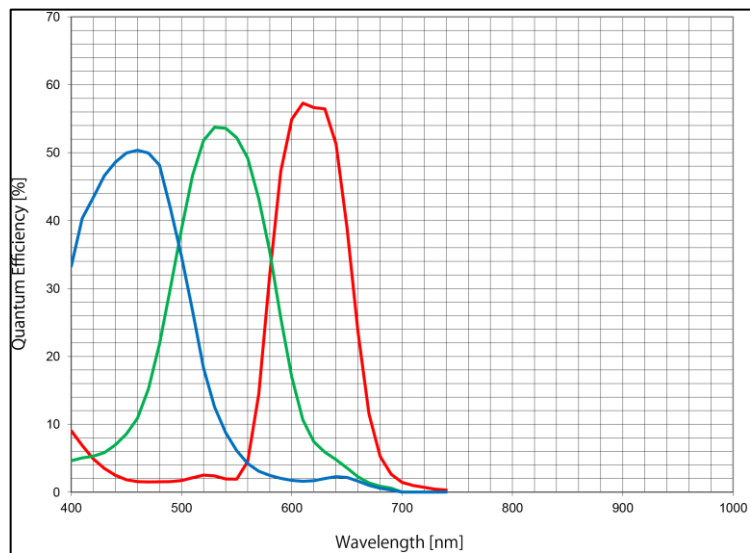

FASTCAM Mini UX

Hardware Manual Rev. 4.10 E

Last Updated February 2025
Written by PHOTRON LIMITED
21F, Jinbocho Mitsui Bldg.,
1-105 Kanda Jimbocho, Chiyoda-Ku,
Tokyo 101-0051, Japan